

# **BC35**

**EDO**

**ELECTRIC ON-OFF  
SECTIONAL VALVE**

<b>LENGTH</b>	1 millimetre (mm) = 0.0394 inch	1 inch = 25.4 millimetre (mm)
<b>PRESSURE</b>	1 bar (gage) = 14.493 pounds per square inch (PSI)	1 pound per square inch (PSI) = 0.069 bar (gage)
<b>VACUUM</b>	0.1 bar (a value less than 1.0) = 2.94 inches of mercury (in Hg) at 15.6 degrees Celsius (°C)	1 inch of mercury (in Hg) = 0.034 bar (a value less than 1.0 at 60° degrees Fahrenheit 1(°F)
<b>FLOW</b>	1 litre per minute (l/min) = 0.264 gallons per minute (GPM) 1 cubic centimetre per minute (cc/min) = 0.000264 gallons per minute (GPM)	1 gallon per minute (GPM) = 3.785 litres per minute (l/min) 1 gallon per minute (GPM) = 3785 cubic centimetres per minute (cc/min)
<b>FORCE</b>	1 Newton (N) = 0.225 pound <sub>f</sub> (lbr)	1 pound <sub>f</sub> (lbr) = 4.44 Newton (N)
<b>MASS</b>	1 kilogram (kg) = 2.20 pound <sub>m</sub> (lbr <sub>m</sub> )	1 pound <sub>m</sub> (lbr <sub>m</sub> ) = 0.455 kilogram (Kg)
<b>TIME</b>	second (s)	second (s)
<b>VOLUME</b>	1 litre (l) = 0.264 US gallon (gal) 1 cubic centimetre (cc) = 0.000264 US gallons (gal)	1 US gallon (gal) = 3.785 litre (l) 1 US gallon (gal) = 3785 cubic centimetres (cc)
<b>TEMPERATURE</b>	°C = 0.556 (°F - 32°)	°F = (1.8 • °C) + 32°
<b>TORQUE</b>	1 Newton metre (N • m) or joule = 8.8 pound <sub>f</sub> inches (lbr - in.)	1 pound <sub>f</sub> inch (lbr - in.) = 0.1136 Newton metre (N • m) or joule
<b>POWER</b>	1 kilowatt (kW) = 1.34 horsepower (HP)	1 horsepower (HP) = 0.746 kilowatt (kW)
<b>SHAFT SPEED</b>	revolutions per minute (rev/min)	revolutions per minute (RPM)
<b>FREQUENCY</b>	1 Hertz (Hz) = 1 cycle per second (cps)	1 cycle per second (cps) = 1 Hertz (Hz)
<b>DISPLACEMENT</b>	1 cubic centimetre per revolution (cc/rev) = 0.061 cubic inches per revolution (cu. in./rev.)	1 cubic inch per revolution (cu. in./rev.) = 16.4 cubic centimetres per revolution (cc/rev)
<b>VELOCITY</b>	1 metre per second (m/s) = 3.28 feet per second (fps)	1 foot per second (fps) = 0.305 metre per second (m/s)

NOTE: 1 cubic (cc) = 1 millilitre (ml) = 0.001 litre (l)

GENERAL INDICATIONS .....	4
TECHNICAL CHARACTERISTICS .....	5
DESIGNATION SAMPLE .....	6
TE INLETS .....	7
S EDO - V EDO STANDARD ELEMENTS .....	8
CF EDO - CFV EDO FLOW CONTROL ELEMENTS .....	9
RFS - RFSO FLOW CONTROL SECTIONS .....	10
RFP - RFPO FLOW CONTROL SECTIONS .....	11
P EDO - PV EDO PRIORITY ELEMENTS .....	12
R EDO - RV EDO RECUPERATION ELEMENTS .....	13
TU OUTLETS .....	14
ELECTRIC JOYSTICKS .....	15
ACCESSORIES .....	16

This booklet is meant to be a technical deepening on the **BC35** directional control valve. Choice, use, maintenance and warranty conditions of all BLB products are described in the BLB General Catalogue.

The **BC35** sectional valve has been designed for the remote electric actuation of systems with fix displacement pumps. However, the installation of an auxiliary electro-valve (**LSK**) allows the utilization of the **BC35** valve in systems with variable displacement pumps (**LS**).

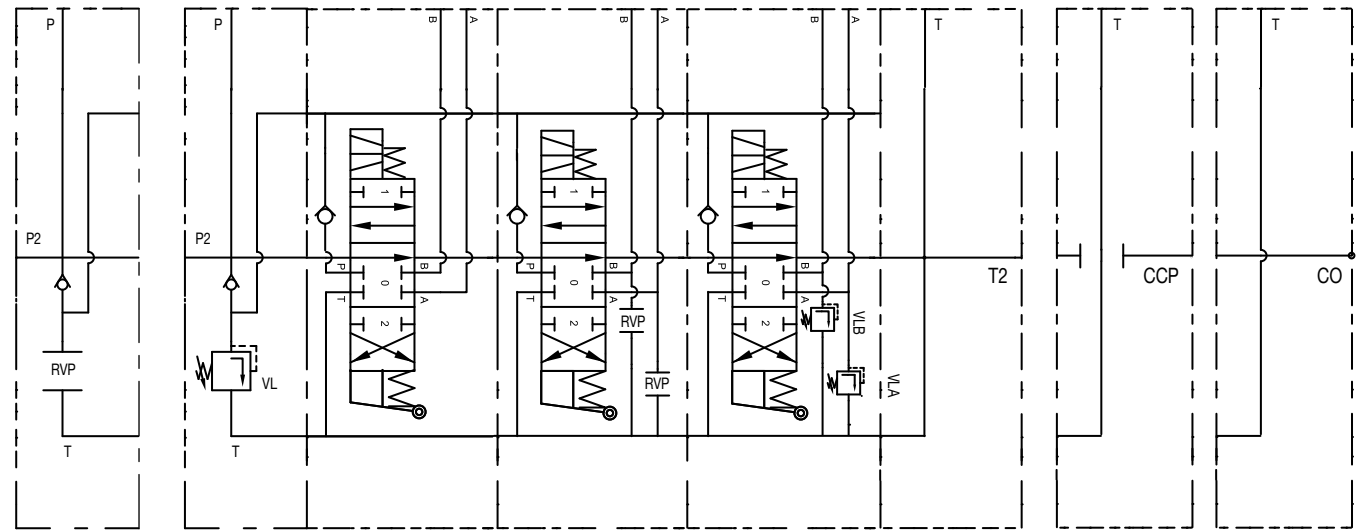
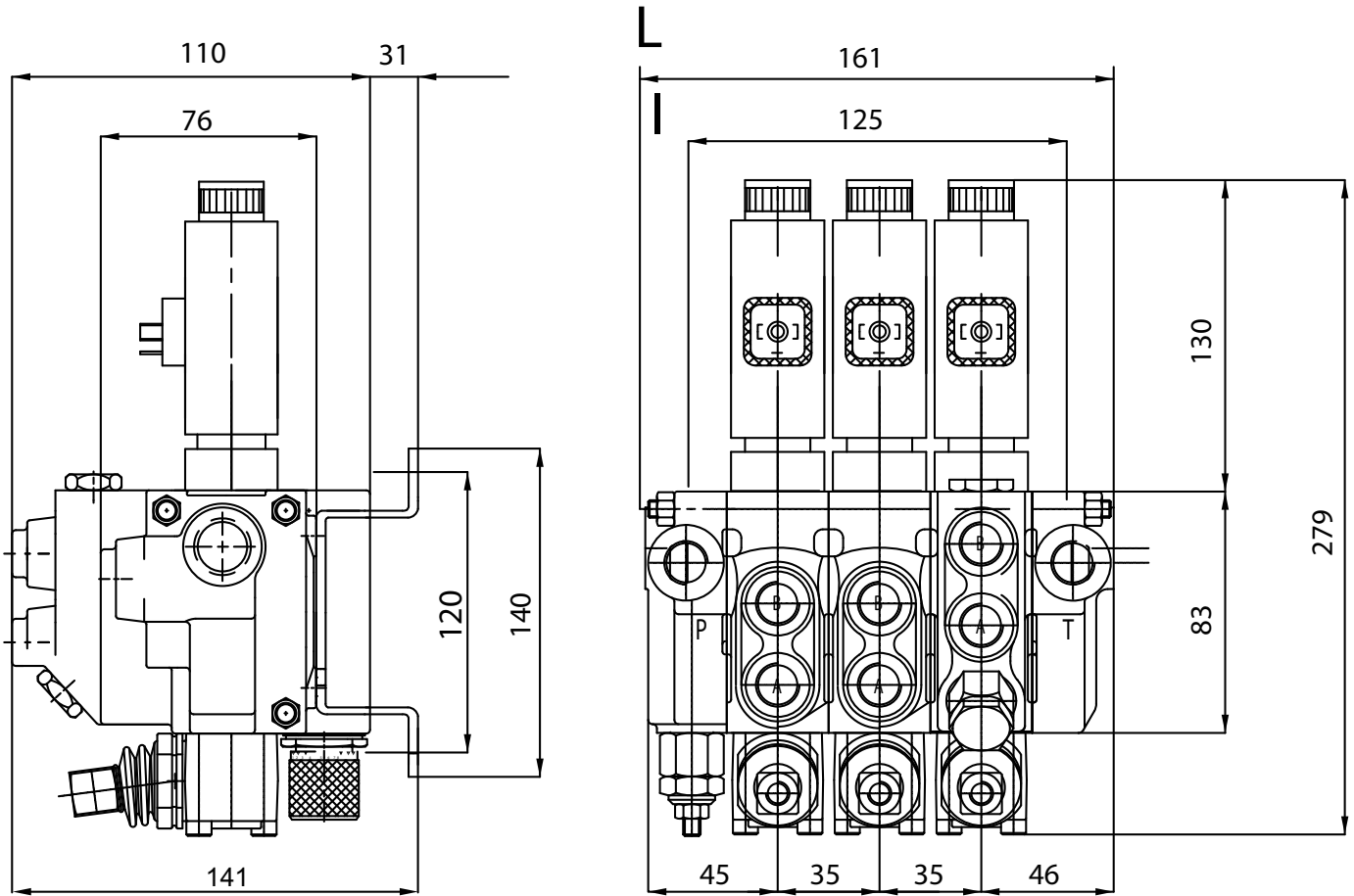

Without relief valve

Open center

Close center

High pressure carry over (power beyond)

The **BC35** sectional valve has the following features:

- Possibility to have auxiliary valves on ports
- Check valves on each section;
- Priority flow control sections (**RFS, RFP**);
- Elements with integrated pressure compensated flow control (**CF, CFV**).

Thanks to its high versatility and modular structure, the **BC35** valve can be used in simple and complex hydraulic systems, fulfilling the most advanced requirements of the modern mobile machines.

TECHNICAL CHARACTERISTICS		
NOMINAL FLOW	30 l/min	8 GPM
MAX FLOW	35 l/min	9,2 GPM
NOMINAL PRESSURE	200 bar	2900 PSI
MAX PRESSURE ON PORTS	250 bar	3600 PSI
MAX PRESSURE ON TANK-LINE	15 bar	220 PSI

INTERNAL OIL LEAKAGE	
From A B to T	4 ÷ 8 cc/min
TESTING CONDITIONS	
Pressure	100 bar
Oil temperature	40 °C
Oil viscosity	32 mm <sup>2</sup> /s

STANDARD THREADS					
	A - B	P	T	P2	T2
G (BSP)	3/8"	3/8"	3/8"	3/8"	3/8"
F (UNF)	3/4"-16	3/4"-16	3/4"-16	3/4"-16	3/4"-16

NUMBER OF SECTIONS	L		I	
	(mm)	(inch)	(mm)	(inch)
BC35/1	91	3,58	55	2,16
BC35/2	126	4,96	90	3,54
BC35/3	161	6,33	125	4,92
BC35/4	196	7,71	160	6,29
...	...	...	...	...

## ACTUATORS

### MO...EDO

Combined push-pull and manual actuator

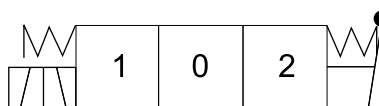

## SPOOL TYPES

### AE

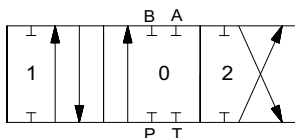

4-WAY / 3-POSITION SPOOL. Provides control of double-acting cylinders or bi-directional hydraulic motors. In position 0 work ports are blocked.

### BE

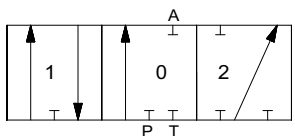

3-WAY / 3-POSITION SPOOL. Provides control of single-acting cylinders or start and stop of uni-directional hydraulic motors. In position 0 work port is blocked. B port is plugged.

### DE

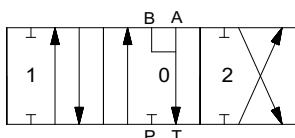

4-WAY / 3-POSITION SPOOL, OPEN CENTER (MOTOR SPOOL). Provides control of double acting cylinders or bi-directional hydraulic motors. Allows a cylinder to float or a motor to wheel free when the spool is in position 0. Work ports are open to the tank port when the spool is in position 0.

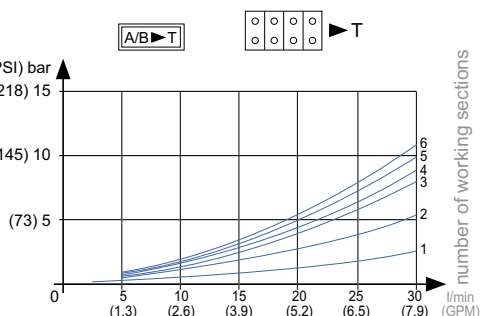
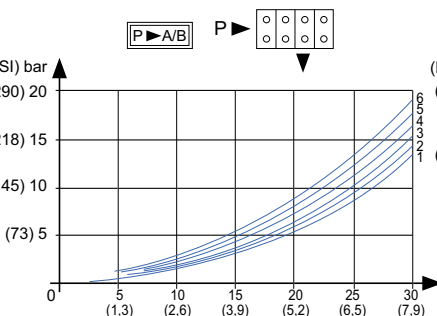
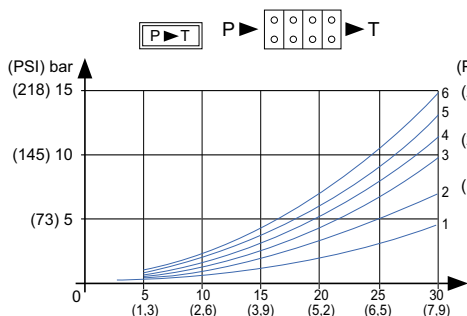

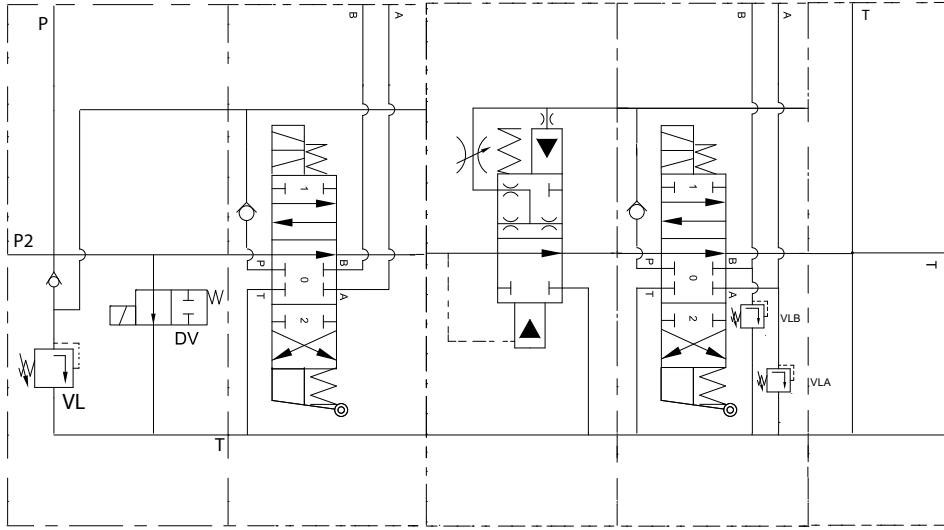

**BC35 / 3 12 DV GK / S MO AE EDO / RFS / V MO AE EDO VLAB / CO**

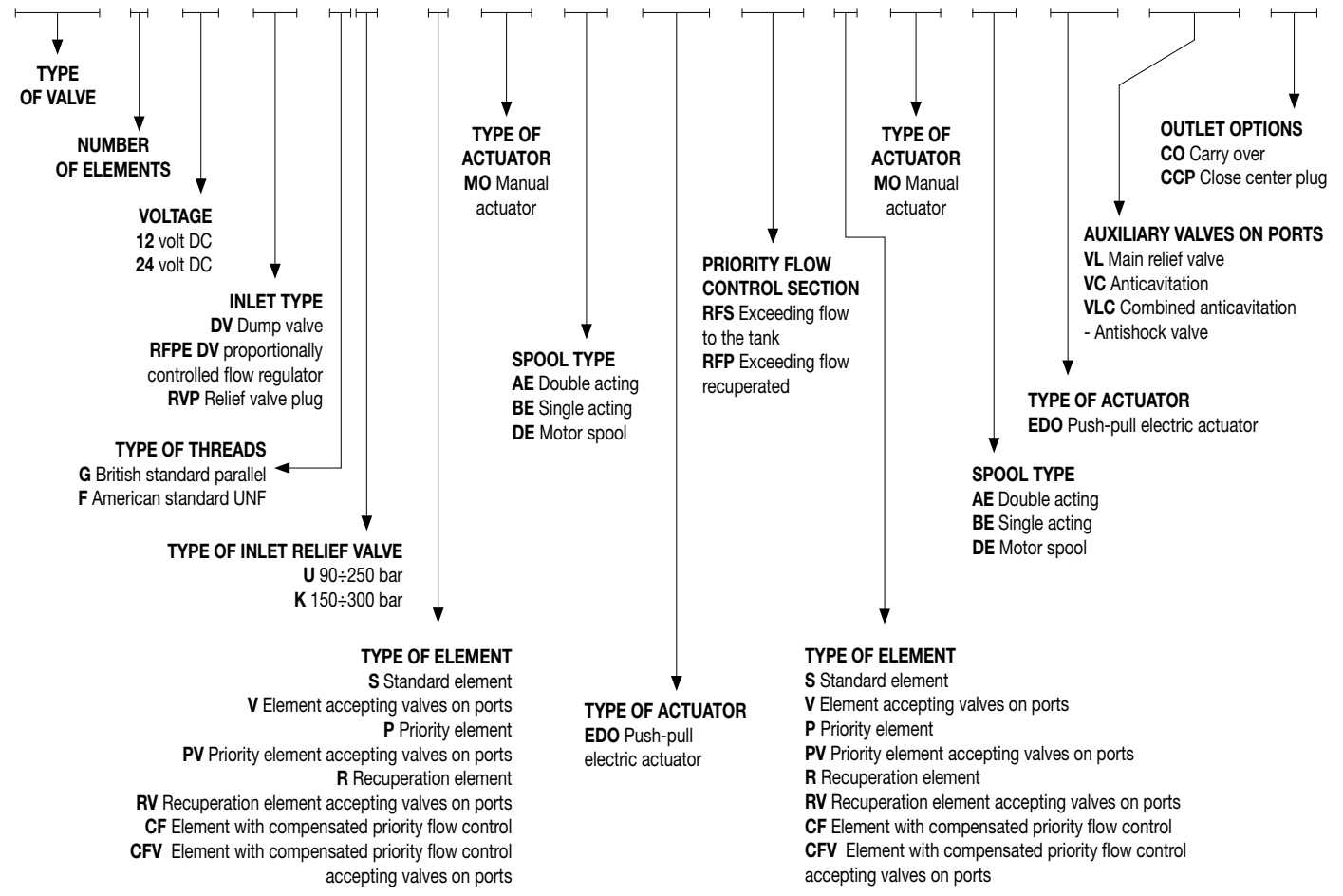

**LEGEND**

- |                       |                                 |  |  |
|-----------------------|---------------------------------|--|--|
| A Port                | DV Dump valve                   | VLAB Antishock valves                  | CCP Close center plug  |
| B Port                | DVP Dump valve plug             | VLC Antishock and anticavitation valve | CO Carry over  |
| P Pump connection     | EDO Push-pull electric actuator | VC Anticavitation valve                |  |
| P2 Pump connection    | MO Manual actuator              | T Tank connection                      | <span style="display:inline-block; width:10px; height:10px; background-color:orange;"></span> <b>MANDATORY FIELD</b> |
| RVP Relief valve plug | VL Main relief valve            | T2 Tank connection                     | <span style="display:inline-block; width:10px; height:10px; background-color:blue;"></span> <b>OPTIONAL FIELD</b>    |

## TE



0,9 kg

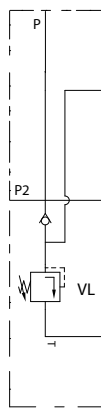

<b>BC35TE GU</b>	805027
<b>BC35TE GK</b>	805057
<b>BC35TE FU</b>	805024
<b>BC35TE FK</b>	805032

## TE DV



2,5 kg

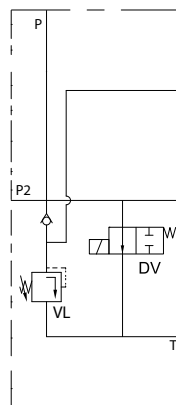

<b>BC35TE DV GU12</b>	805186
<b>BC35TE DV GU24</b>	805139
<b>BC35TE DV GK12</b>	805187
<b>BC35TE DV GK24</b>	805188
<b>BC35TE DV FU12</b>	805189
<b>BC35TE DV FU24</b>	805190
<b>BC35TE DV FK12</b>	805191
<b>BC35TE DV FK24</b>	805192

**DV** dump valve prevents the unwanted or accidental use of the directional control valve, connecting the pump flow to the tank.

## TE RFPE DV



3,1 kg

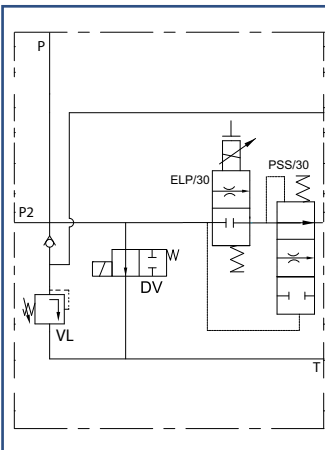

<b>BC35TE RFPE DV GU 12</b>	805135
<b>BC35TE RFPE DV GU 24</b>	805193
<b>BC35TE RFPE DV GK 12</b>	805194
<b>BC35TE RFPE DV GK 24</b>	805195
<b>BC35TE RFEP DV FU 12</b>	805196
<b>BC35TE RFEP DV FU 24</b>	805197
<b>BC35TE RFEP DV FK 12</b>	805198
<b>BC35TE RFEP DV FK 24</b>	805199

The **BC35TE RFPE DV** inlet features a dump valve that prevents the unwanted or accidental use of the directional control valve, connecting the pump flow to the tank.

It also features a logic valve (**ELP/30**) and a proportionally controlled flow regulator (**PSS/30**).

The combination of these two elements allows the proportional regulation of the flow going to following elements, connecting to the tank the exceeding flow not needed.

STANDARD ELEMENT



S

2,2 kg

STANDARD ELEMENT  
ACCEPTING  
VALVES  
ON PORTS

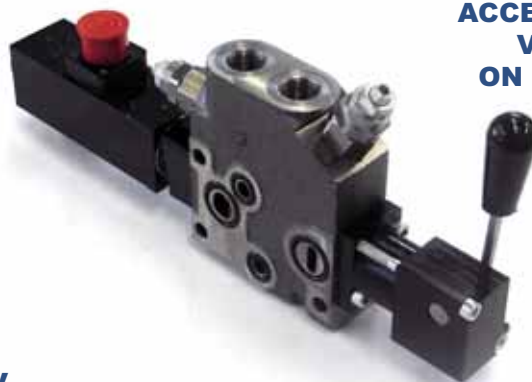

V

2,7 kg

BC35S 12 G /MO AE EDO/	807638
BC35S 24 G /MO AE EDO/	807640
BC35S 12 F /MO AE EDO/	807650
BC35S 24 F /MO AE EDO/	807888

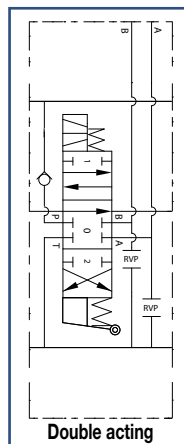
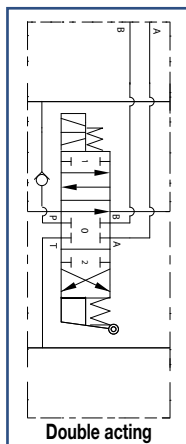

BC35V 12 G /MO AE EDO RVPAB/	807644
BC35V 24 G /MO AE EDO RVPAB/	807897
BC35V 12 F /MO AE EDO RVPAB/	807898
BC35V 24 F /MO AE EDO RVPAB/	807899

BC35V 12 G /MO AE EDO VLAB/	807900
BC35V 24 G /MO AE EDO VLAB/	807901
BC35V 12 F /MO AE EDO VLAB/	807902
BC35V 24 F /MO AE EDO VLAB/	807903

VL valves on ports **A** and **B** are type **U**.  
Standard setting 140 bar.

BC35S 12 G /MO BE EDO/	807889
BC35S 24 G /MO BE EDO/	807890
BC35S 12 F /MO BE EDO/	807891
BC35S 24 F /MO BE EDO/	807892

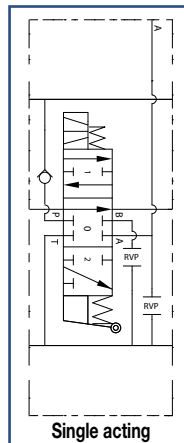
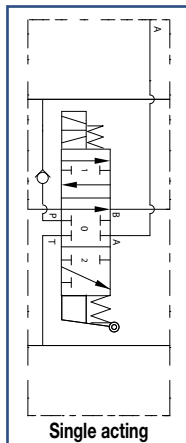

BC35V 12 G /MO BE EDO RVPAB/	807904
BC35V 24 G /MO BE EDO RVPAB/	807905
BC35V 12 F /MO BE EDO RVPAB/	807906
BC35V 24 F /MO BE EDO RVPAB/	807907

BC35V 12 G /MO BE EDO VLAB/	807908
BC35V 24 G /MO BE EDO VLAB/	807909
BC35V 12 F /MO BE EDO VLAB/	807910
BC35V 24 F /MO BE EDO VLAB/	807911

VL valves on ports **A** and **B** are type **U**.  
Standard setting 140 bar.

BC35S 12 G /MO DE EDO/	807893
BC35S 24 G /MO DE EDO/	807894
BC35S 12 F /MO DE EDO/	807895
BC35S 24 F /MO DE EDO/	807896

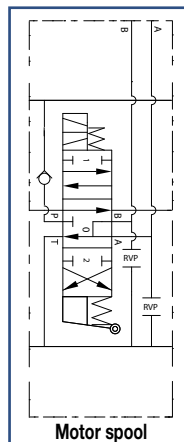
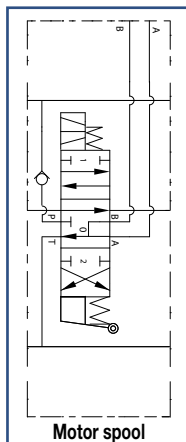

BC35V 12 G /MO DE EDO RVPAB/	807912
BC35V 24 G /MO DE EDO RVPAB/	807913
BC35V 12 F /MO DE EDO RVPAB/	807914
BC35V 24 F /MO DE EDO RVPAB/	807915

BC35V 12 G /MO DE EDO VLAB/	807916
BC35V 24 G /MO DE EDO VLAB/	807917
BC35V 12 F /MO DE EDO VLAB/	807918
BC35V 24 F /MO DE EDO VLAB/	807919

VL valves on ports **A** and **B** are type **U**.  
Standard setting 140 bar.



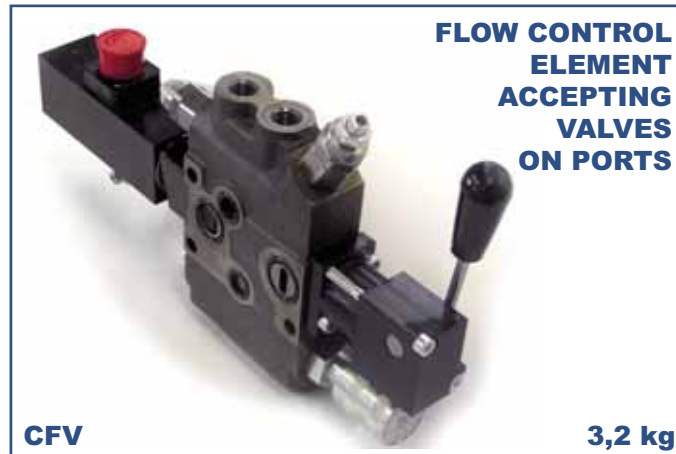
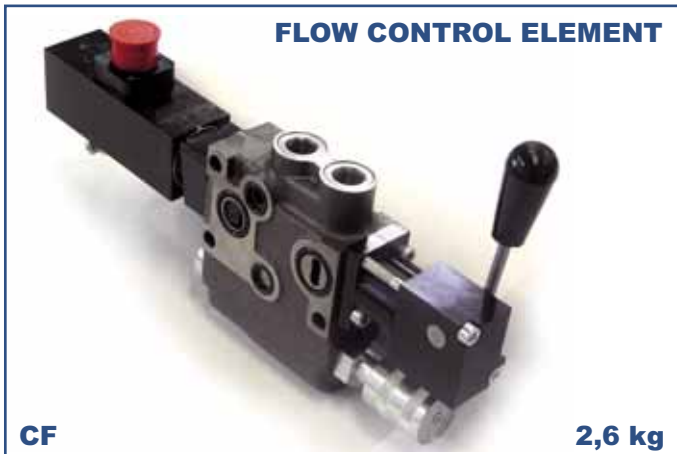

CF and CFV elements integrate a pressure compensated flow control that allows the external regulation of the flow inside the elements themselves and recuperates the exceeding flow (EF) for the following elements.

BC35CF 12 G /MO AE EDO/	807920
BC35CF 24 G /MO AE EDO/	807921
BC35CF 12 F /MO AE EDO/	807922
BC35CF 24 F /MO AE EDO/	807923

BC35CF 12 G /MO BE EDO/	807924
BC35CF 24 G /MO BE EDO/	807925
BC35CF 12 F /MO BE EDO/	807926
BC35CF 24 F /MO BE EDO/	807927

BC35CF 12 G /MO DE EDO/	807928
BC35CF 24 G /MO DE EDO/	807929
BC35CF 12 F /MO DE EDO/	807930
BC35CF 24 F /MO DE EDO/	807931

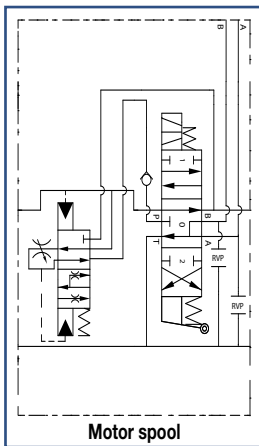
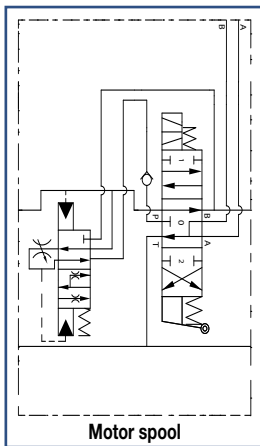
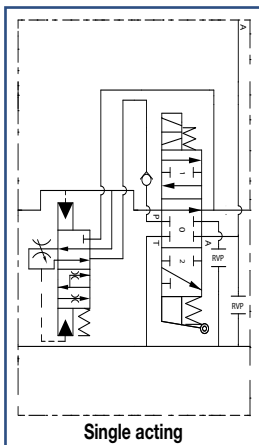
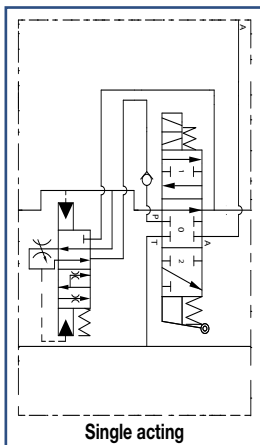
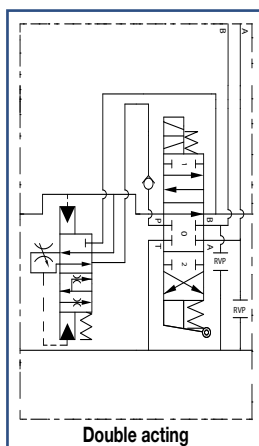
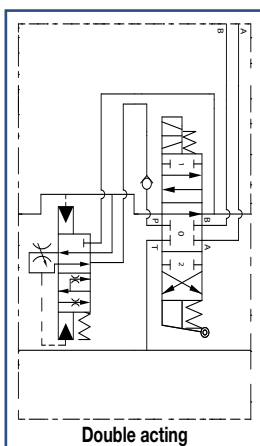

BC35CFV 12 G /MO AE EDO RVPAB/	807932
BC35CFV 24 G /MO AE EDO RVPAB/	807933
BC35CFV 12 F /MO AE EDO RVPAB/	807934
BC35CFV 24 F /MO AE EDO RVPAB/	807935

BC35CFV 12 G /MO AE EDO VLAB/	807936
BC35CFV 24 G /MO AE EDO VLAB/	807937
BC35CFV 12 F /MO AE EDO VLAB/	807938
BC35CFV 24 F /MO AE EDO VLAB/	807939

VL valves on ports A and B are type U. Standard setting 140 bar.

BC35CFV 12 G /MO BE EDO RVPAB/	807940
BC35CFV 24 G /MO BE EDO RVPAB/	807941
BC35CFV 12 F /MO BE EDO RVPAB/	807942
BC35CFV 24 F /MO BE EDO RVPAB/	807943

BC35CFV 12 G /MO BE EDO VLAB/	807944
BC35CFV 24 G /MO BE EDO VLAB/	807945
BC35CFV 12 F /MO BE EDO VLAB/	807946
BC35CFV 24 F /MO BE EDO VLAB/	807947

VL valves on ports A and B are type U. Standard setting 140 bar.

BC35CFV 12 G /MO DE EDO RVPAB/	807948
BC35CFV 24 G /MO DE EDO RVPAB/	807949
BC35CFV 12 F /MO DE EDO RVPAB/	807950
BC35CFV 24 F /MO DE EDO RVPAB/	807951

BC35CFV 12 G /MO DE EDO VLAB/	807952
BC35CFV 24 G /MO DE EDO VLAB/	807953
BC35CFV 12 F /MO DE EDO VLAB/	807954
BC35CFV 24 F /MO DE EDO VLAB/	807955

VL valves on ports A and B are type U. Standard setting 140 bar.

**NOTE:** After a CF or CFV the first element must be a R type

VERTICAL



1,2 kg

HORIZONTAL



1,2 kg

The pressure compensated flow control section **RFS**, divides the flow in two channels: the priority flow (**PF**) channel, adjustable with the external knob, and the exceeding flow (**EF**) channel that goes to tank. Elements preceding **RFS** sections receive the full pump flow whereas the elements following **RFS** sections receive just the flow requested and settled. In order to prevent undesired heating in the system, the **RFS** section works only when one or more of the following sections are operated. The **RFS** section can be combined with all standard elements.

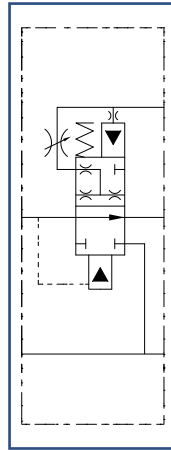

BC35 RFS	835078
BC35 RFSO	835081

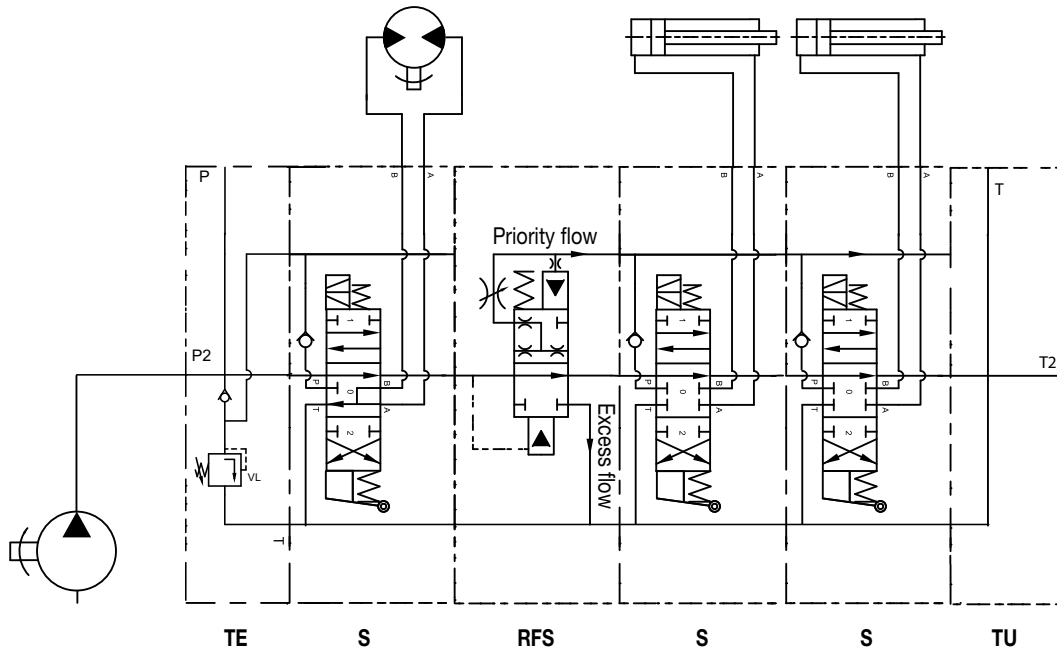

**EXAMPLE** The motor (A) is fed by the whole flow of the pump. The cylinders (C, D) downstream the flow control element (RFS) are fed only by the priority flow (PF) which is adjustable through the flow control knob on the element. The excess flow goes to tank.

VERTICAL



1,2 kg

HORIZONTAL



1,2 kg

The pressure compensated flow control section **RFP**, divides the flow in two channels: the first channel receives the priority flow (**PF**) (adjustable with the external knob) and feeds one or more Priority elements (**P**, **PV**); the second channel receives the exceeding flow (**EF**) and feeds one or more Recuperation elements (**R**, **RV**) which follow the priority ones. **RFP** sections, have to be followed by one or more priority elements (**P**, **PV**); Priority elements have to be followed by one or more Recuperation elements (**R**, **RV**). In order to prevent undesired heating in the system the **RFP** section works only when one or more of the Priority sections are operated. The installation of an **RFP** section, allows the contemporaneous operation of one Priority element and one Recuperation element which will work at different flows and pressures without interfering one with the other. When no Priority section is operated, the Recuperation elements get the full pump flow.

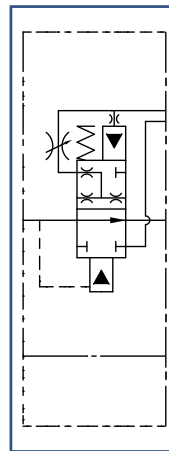

BC35 RFP	835079
BC35 RFPO	835122

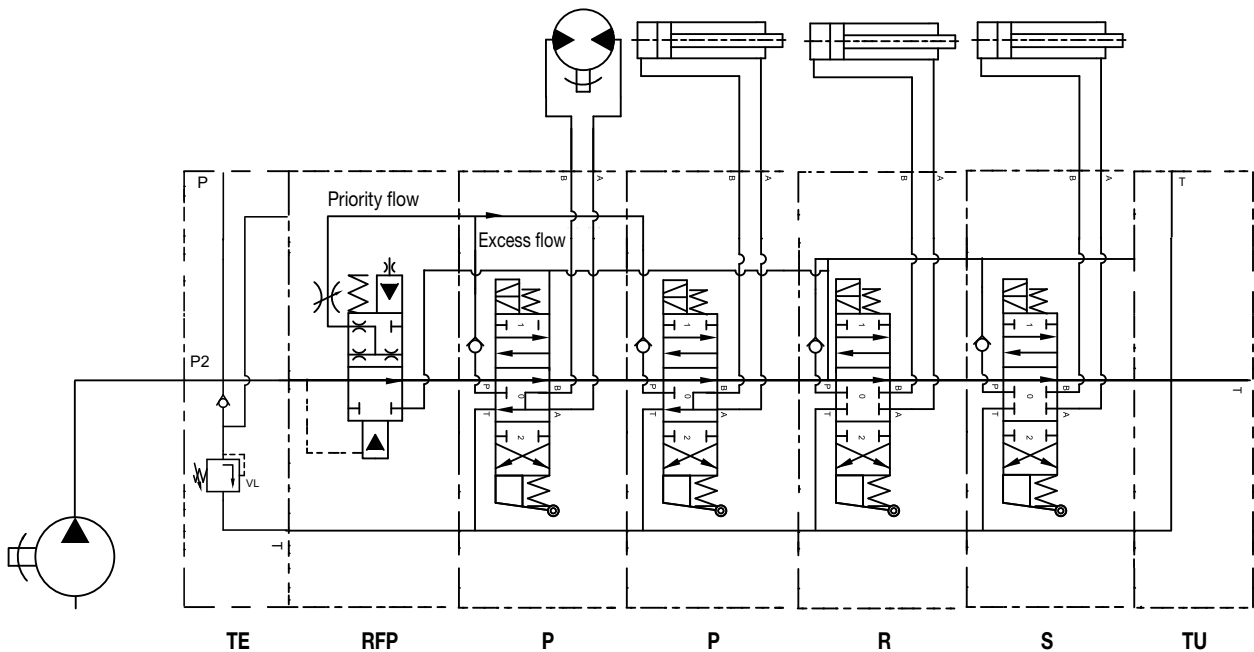

**EXAMPLE** The motors (A, B) are fed by the priority flow (PF) which is adjustable through the flow control knob on the element. The cylinders (C, D) are fed by the whole flow of the pump when singly actuated. When a cylinder and a motor are simultaneously actuated, the motor is fed by the priority flow (PF) and the cylinder by the exceeding flow (EF). If a cylinder is actuated while a motor is in work, this last will not vary its rotation speed.

**PRIORITY ELEMENT**



**P**

**2,2 kg**

P elements use the priority flow regulated by the RFP sections. They have to be installed after an RFP section.

BC35P 12 G /MO AE EDO/	807956
BC35P 24 G /MO AE EDO/	807957
BC35P 12 F /MO AE EDO/	807958
BC35P 24 F /MO AE EDO/	807959

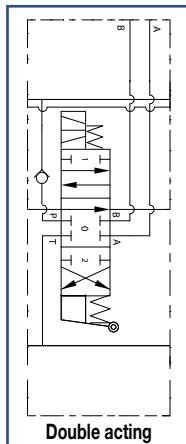

BC35P 12 G /MO BE EDO/	807960
BC35P 24 G /MO BE EDO/	807961
BC35P 12 F /MO BE EDO/	807962
BC35P 24 F /MO BE EDO/	807963

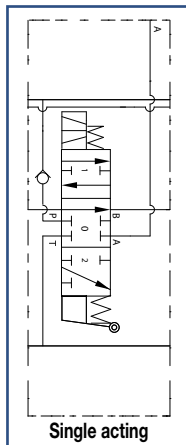

BC35P 12 G /MO DE EDO/	807964
BC35P 24 G /MO DE EDO/	807965
BC35P 12 F /MO DE EDO/	807966
BC35P 24 F /MO DE EDO/	807967

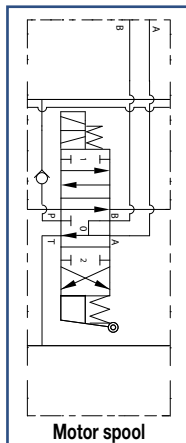

**PRIORITY ELEMENT ACCEPTING VALVES ON PORTS**

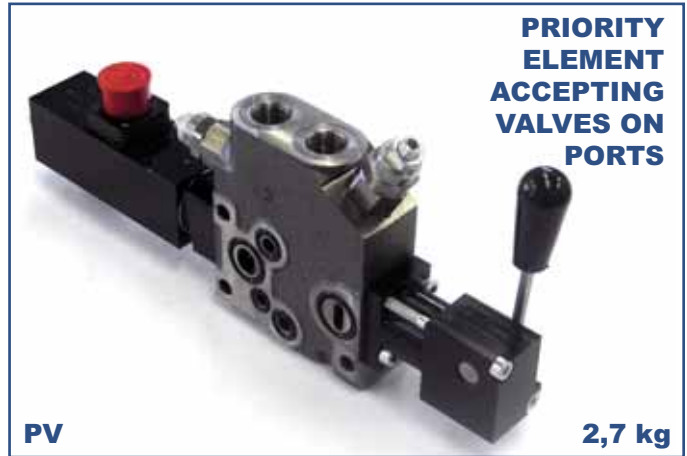

**PV**

**2,7 kg**

BC35PV 12 G /MO AE EDO RVPAB/	807968
BC35PV 24 G /MO AE EDO RVPAB/	807969
BC35PV 12 F /MO AE EDO RVPAB/	807970
BC35PV 24 F /MO AE EDO RVPAB/	807971

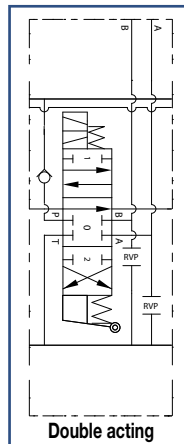

BC35PV 12 G /MO AE EDO VLAB/	807972
BC35PV 24 G /MO AE EDO VLAB/	807973
BC35PV 12 F /MO AE EDO VLAB/	807974
BC35PV 24 F /MO AE EDO VLAB/	807975

VL valves on ports A and B are type U. Standard setting 140 bar.

BC35PV 12 G /MO BE EDO RVPAB/	807976
BC35PV 24 G /MO BE EDO RVPAB/	807977
BC35PV 12 F /MO BE EDO RVPAB/	807978
BC35PV 24 F /MO BE EDO RVPAB/	807979

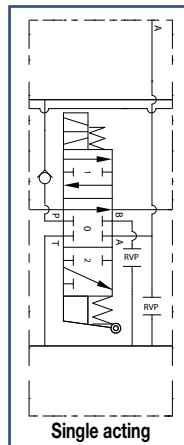

BC35PV 12 G /MO BE EDO VLAB/	807980
BC35PV 24 G /MO BE EDO VLAB/	807981
BC35PV 12 F /MO BE EDO VLAB/	807982
BC35PV 24 F /MO BE EDO VLAB/	807983

VL valves on ports A and B are type U. Standard setting 140 bar.

BC35PV 12 G /MO DE EDO RVPAB/	807984
BC35PV 24 G /MO DE EDO RVPAB/	807985
BC35PV 12 F /MO DE EDO RVPAB/	807986
BC35PV 24 F /MO DE EDO RVPAB/	807987

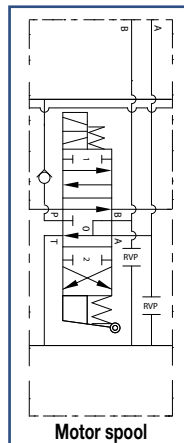

BC35PV 12 G /MO DE EDO VLAB/	807988
BC35PV 24 G /MO DE EDO VLAB/	807989
BC35PV 12 F /MO DE EDO VLAB/	807990
BC35PV 24 F /MO DE EDO VLAB/	807991

VL valves on ports A and B are type U. Standard setting 140 bar.

RECUPERATION ELEMENT

RECUPERATION ELEMENT ACCEPTING VALVES ON PORTS

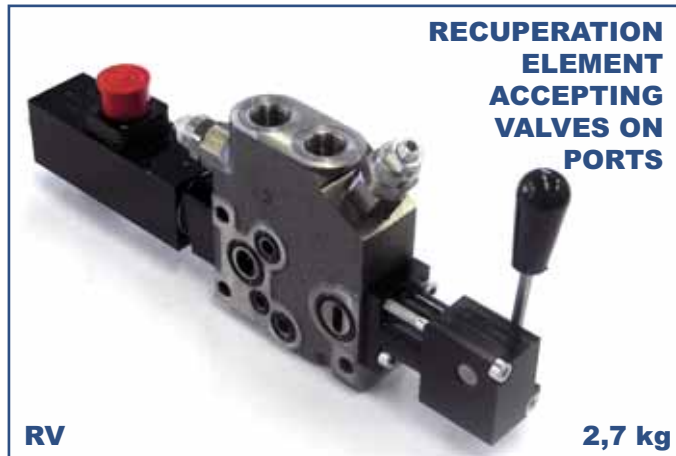
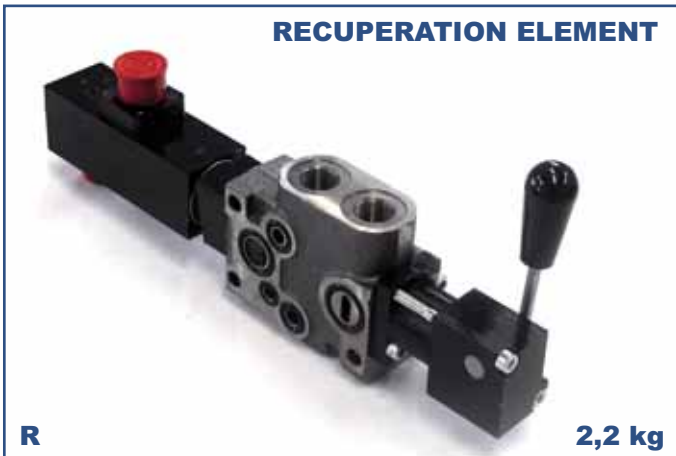

R elements use the exceeding flow coming from an RFP section. They have to be installed only after one or more P elements.

BC35R 12 G /MO AE EDO/	807992
BC35R 24 G /MO AE EDO/	807993
BC35R 12 F /MO AE EDO/	807994
BC35R 24 F /MO AE EDO/	807995

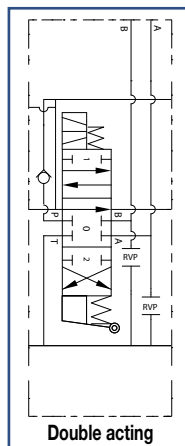
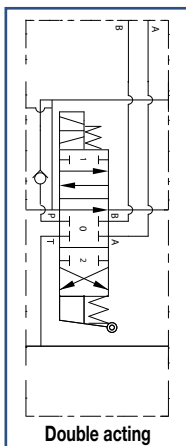

BC35RV 12 G /MO AE EDO RVPAB/	808005
BC35RV 24 G /MO AE EDO RVPAB/	808006
BC35RV 12 F /MO AE EDO RVPAB/	808007
BC35RV 24 F /MO AE EDO RVPAB/	808008

BC35RV 12 G /MO AE EDO VLAB/	808009
BC35RV 24 G /MO AE EDO VLAB/	808010
BC35RV 12 F /MO AE EDO VLAB/	808011
BC35RV 24 F /MO AE EDO VLAB/	808012

VL valves on ports A and B are type U. Standard setting 140 bar.

BC35R 12 G /MO BE EDO/	807996
BC35R 24 G /MO BE EDO/	807997
BC35R 12 F /MO BE EDO/	807998
BC35R 24 F /MO BE EDO/	807999

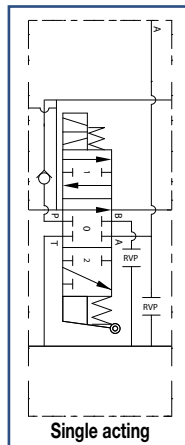
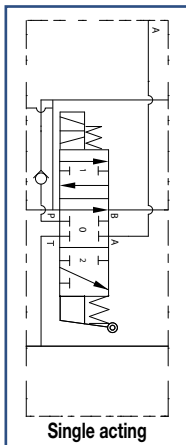

BC35RV 12 G /MO BE EDO RVPAB/	808013
BC35RV 24 G /MO BE EDO RVPAB/	808014
BC35RV 12 F /MO BE EDO RVPAB/	808015
BC35RV 24 F /MO BE EDO RVPAB/	808016

BC35RV 12 G /MO BE EDO VLAB/	808017
BC35RV 24 G /MO BE EDO VLAB/	808018
BC35RV 12 F /MO BE EDO VLAB/	808019
BC35RV 24 F /MO BE EDO VLAB/	808020

VL valves on ports A and B are type U. Standard setting 140 bar.

BC35R 12 G /MO DE EDO/	808001
BC35R 24 G /MO DE EDO/	808002
BC35R 12 F /MO DE EDO/	808003
BC35R 24 F /MO DE EDO/	808004

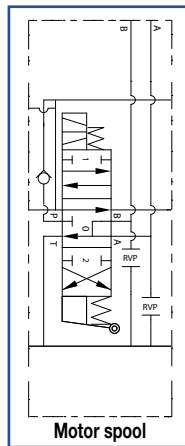
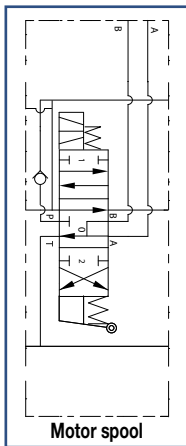

BC35RV 12 G /MO DE EDO RVPAB/	808021
BC35RV 24 G /MO DE EDO RVPAB/	808022
BC35RV 12 F /MO DE EDO RVPAB/	808023
BC35RV 24 F /MO DE EDO RVPAB/	808024

BC35RV 12 G /MO DE EDO VLAB/	808025
BC35RV 24 G /MO DE EDO VLAB/	808026
BC35RV 12 F /MO DE EDO VLAB/	808027
BC35RV 24 F /MO DE EDO VLAB/	808028

VL valves on ports A and B are type U. Standard setting 140 bar.

## OUTLET



TU

0,8 kg

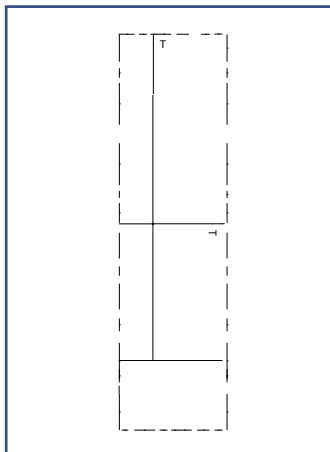

<b>BC35TU G</b>	805028
<b>BC35TU F</b>	805025

## OUTLET



TU

1,9 kg

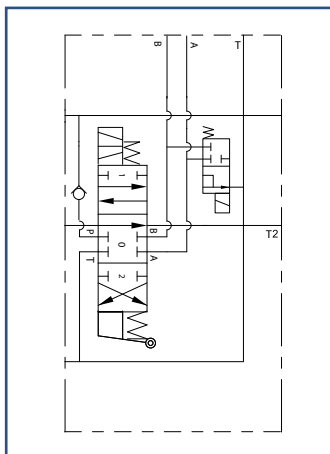

<b>BC35TU 12 KEO G</b>	805134
<b>BC35TU 24 KEO G</b>	805184
<b>BC35TU 12 KEO F</b>	805185
<b>BC35TU 24 KEO F</b>	805186

**BC35TE KEO** outlet features an electric 3 ways valve. Connected to a special element, this valve, when operated, connects **A** and **B** ports to tank, allowing a cylinder or a motor to float.



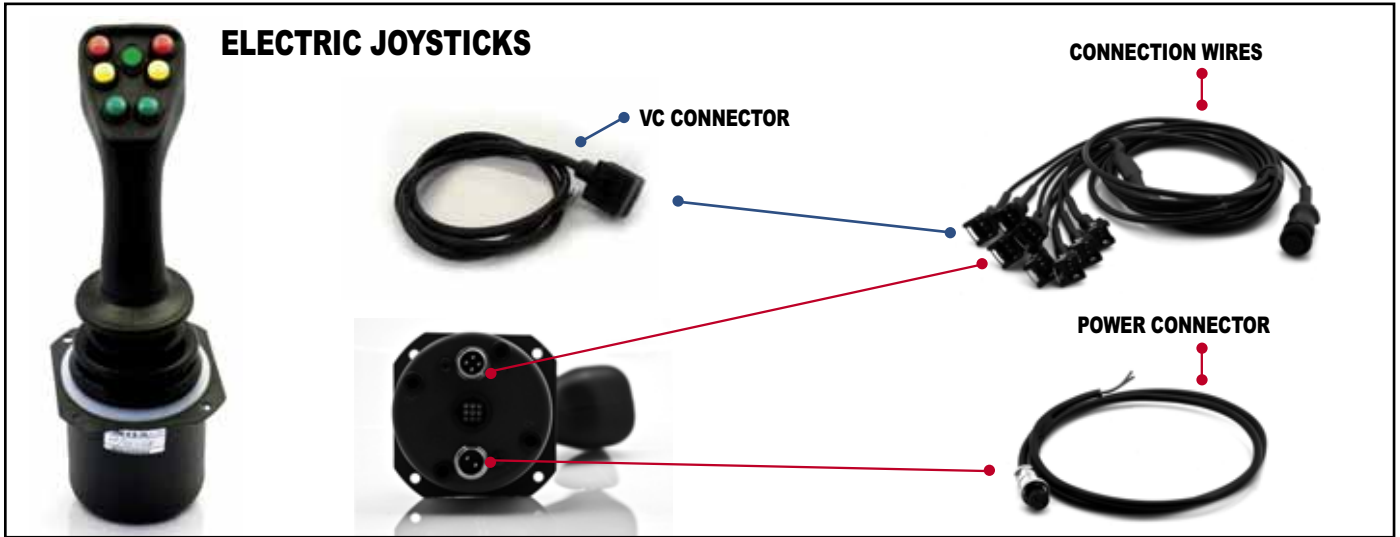

**ELECTRIC JOYSTICK WITH 1 AXIS AND MICROSWITCHES**

1 axis version for the control of one element in the BC35 valve. On request, extra microswitches will be available for the operation of further elements (up to 10 switches).

<b>JME 2S</b>	023065
<b>JME 4S</b>	023066
<b>JME 6S</b>	023067
<b>JME 8S</b>	023068
<b>JME 10S</b>	023069



**ELECTRIC JOYSTICK WITH 2 AXIS AND MICROSWITCHES**

2 axes version for the control of two elements in the BC35 valve. On request, extra microswitches will be available for the operation of further elements (up to 10 switches).

<b>JSE 2S</b>	023062
<b>JSE 4S</b>	023063
<b>JSE 6S</b>	023061
<b>JSE 8S</b>	023060
<b>JSE 10S</b>	023064



**ELECTRIC PROPORTIONAL JOYSTICK WITH 1 AXIS**

Electric proportional joystick complete with electronic card. 1 axis version for the control of the TE RFPE DV Inlet. On request, extra microswitches will be available for the operation of further elements (up to 10 switches).

<b>JMP 2S</b>	023110
<b>JMP 4S</b>	023111
<b>JMP 6S</b>	023112
<b>JMP 8S</b>	023113
<b>JMP 10S</b>	023114



**VCC CONNECTION WIRES**

Electric wires to connect the joystick to the valve. Standard length 4.50 meters.

<b>VCC E2S</b>	025105
<b>VCC E4S</b>	025106
<b>VCC E6S</b>	025107
<b>VCC E8S</b>	025108
<b>VCC E10S</b>	025109



**PC POWER CONNECTOR**

Connects the joystick to the power source. Standard length 4.50 meters.

<b>PC</b>	025110
-----------	--------



**VC CONNECTOR**

Valve connector that allows kinds of wiring different from the usual.

<b>VC</b>	025045
-----------	--------

**CO CARRY OVER** Allows the installation of another valve downstream from the first. To be assembled on T2 port of the valve.

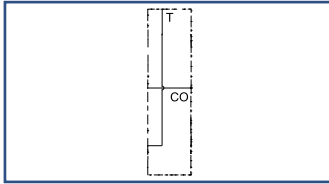

<b>CO G</b>	832019
<b>CO F</b>	832032

**CCP CLOSE CENTER PLUG** Turns an open center circuit into a close center one.

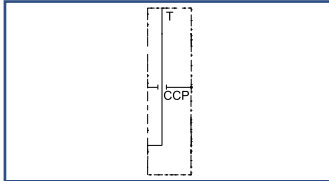

<b>CCP G</b>	832017
<b>CCP F</b>	832033

**RVP RELIEF VALVE PLUG** Replaces the relief valve in close center systems where the relief valve is not required.

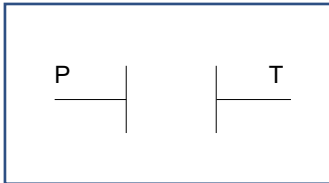

<b>RVP</b>	832018
------------	--------

**PB RELIEF VALVE LOCK KIT** Prevents users from altering the factory relief valve setting.



<b>PB</b>	560926
-----------	--------

**BRACKETS KIT**

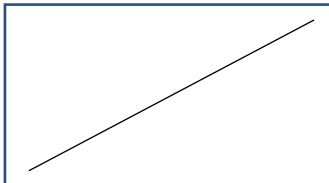

<b>BRACKETS</b>	560893
-----------------	--------

**TIE RODS KIT FOR STANDARD TE**



<b>BC35/1</b>	560062
<b>BC35/2</b>	560063
<b>BC35/3</b>	560064
<b>BC35/4</b>	560065
<b>BC35/5</b>	560066

<b>BC35/6</b>	560067
<b>BC35/7</b>	560207
<b>BC35/8</b>	560208
<b>BC35/9</b>	560209
<b>BC35/10</b>	560210

**TIE RODS KIT FOR TE DV - TE RFPE DV**



<b>BC35/1</b>	560960
<b>BC35/2</b>	560961
<b>BC35/3</b>	560962
<b>BC35/4</b>	560963
<b>BC35/5</b>	560964

<b>BC35/6</b>	560965
<b>BC35/7</b>	560966
<b>BC35/8</b>	560967
<b>BC35/9</b>	560968
<b>BC35/10</b>	560969