

BC35

3/8" Dual operation.. lever and electric solenoid valve



Technical Characteristics	l/min	
	Nominal Flow	30
Max Flow	35	
	bar	psi
Nominal Pressure	200	2900
Max Pressure on Ports	250	3600
Max Pressure in Tank Line	15	220

TEL. 0118 978 2555

FAX. 0118 978 2545

SALES@HYCON.CO.UK

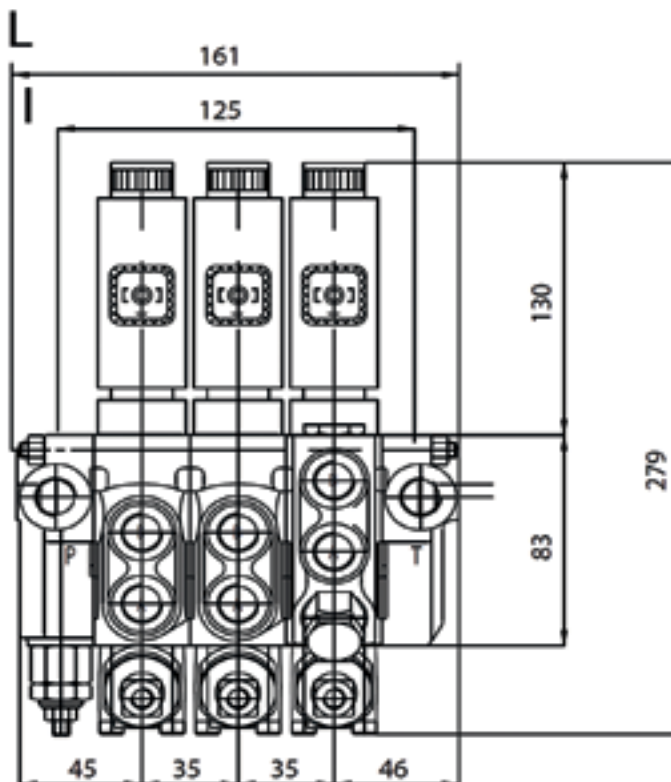
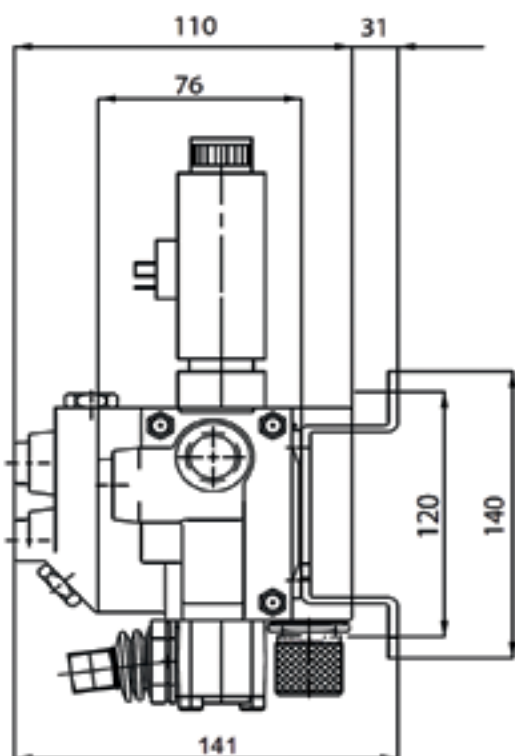

Thread size	A & B	P	T	P2	T2
G	3/8"	3/8"	3/8"	3/8"	3/8"

Number of spools	L	I
BC35/1	91	55
BC35/2	126	90
BC35/3	161	125
BC35/4	196	160

Options	CODE
High Pressure Carry Over	CO
Relief Valve Plug	RVP
Manual lever & electric solenoid operation	MO EDO
Manual lever operation	MO
Closed centre plug	CCP

BC35

Dual operation.. lever and electric solenoid valve

ACTUATORS

MO...EDO
Combined push-pull and manual actuator

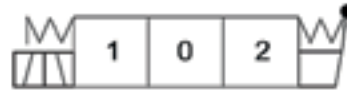

SPOOL TYPES

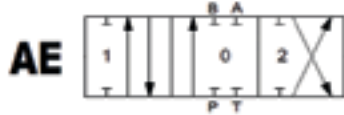

4-WAY / 3-POSITION SPOOL. Provides control of double-acting cylinders or bi-directional hydraulic motors. In position 0 work ports are blocked.

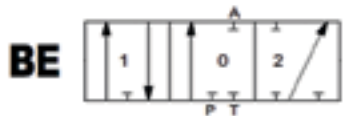

3-WAY / 3-POSITION SPOOL. Provides control of single-acting cylinders or start and stop of uni-directional hydraulic motors. In position 0 work port is blocked. B port is plugged.

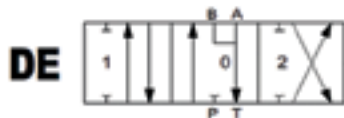

4-WAY / 3-POSITION SPOOL, OPEN CENTER (MOTOR SPOOL). Provides control of double acting cylinders or bi-directional hydraulic motors. Allows a cylinder to float or a motor to wheel free when the spool is in position 0. Work ports are open to the tank port when the spool is in position 0.

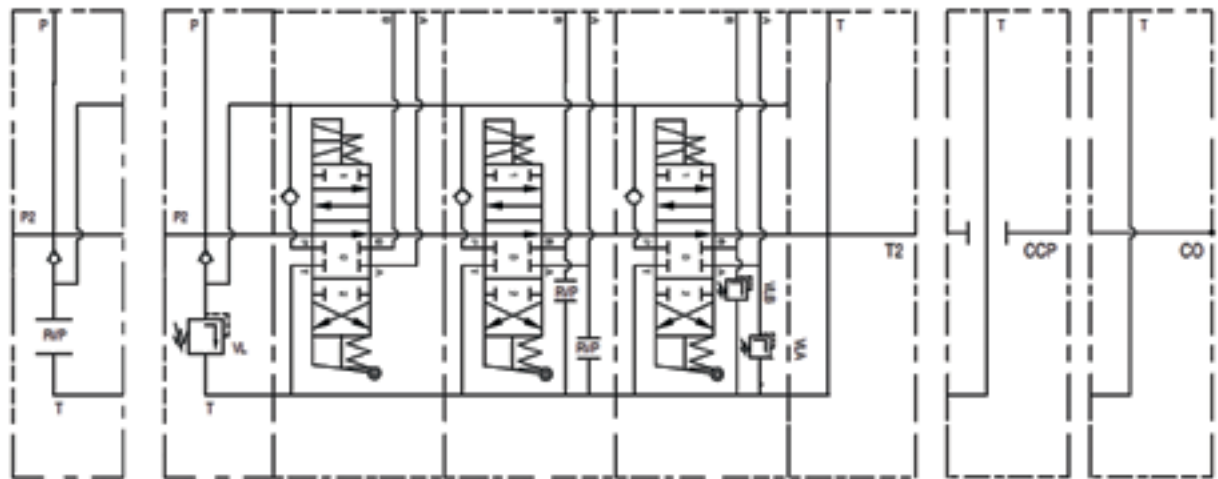

Without relief valve

Open center

Close center

High pressure carry over (power beyond)

BC35

Dual operation.. lever and electric solenoid valve

Inlet covers

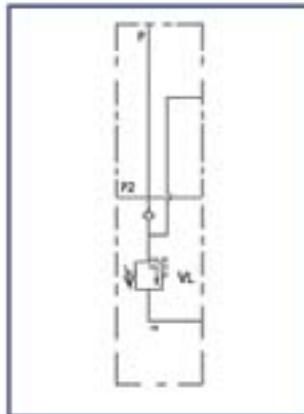

BC35TE GU	805027
BC35TE GK	805057
BC35TE FU	805024
BC35TE FK	805032

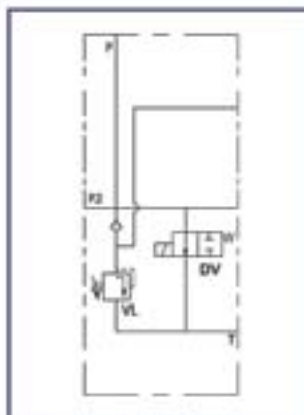

BC35TE DV GU12	805186
BC35TE DV GU24	805139
BC35TE DV GK12	805187
BC35TE DV GK24	805188
BC35TE DV FU12	805189
BC35TE DV FU24	805190
BC35TE DV FK12	805191
BC35TE DV FK24	805192

DV dump valve prevents the unwanted or accidental use of the directional control valve, connecting the pump flow to the tank.

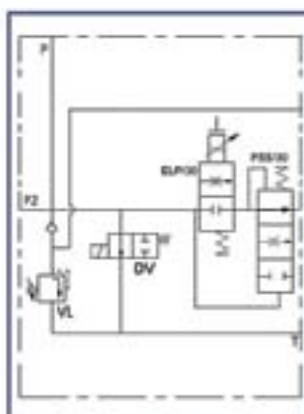

BC35TE RFPE DV GU 12	805135
BC35TE RFPE DV GU 24	805193
BC35TE RFPE DV GK 12	805194
BC35TE RFPE DV GK 24	805195
BC35TE RFPE DV FU 12	805196
BC35TE RFPE DV FU 24	805197
BC35TE RFPE DV FK 12	805198
BC35TE RFPE DV FK 24	805199

The **BC35TE RFPE DV** inlet features a dump valve that prevents the unwanted or accidental use of the directional control valve, connecting the pump flow to the tank.

It also features a logic valve (**ELP/30**) and a proportionally controlled flow regulator (**PSS/30**).

The combination of these two elements allows the proportional regulation of the flow going to following elements, connecting to the tank the exceeding flow not needed.

BC35

Dual operation.. lever and electric solenoid valve

Standard elements



BC35S 12 G /MO AE EDO/	807638
BC35S 24 G /MO AE EDO/	807640
BC35S 12 F /MO AE EDO/	807650
BC35S 24 F /MO AE EDO/	807888

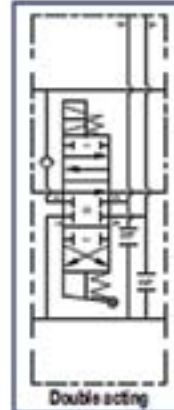
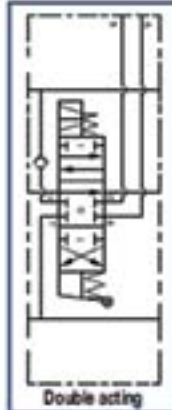

BC35V 12 G /MO AE EDO RVPAB/	807644
BC35V 24 G /MO AE EDO RVPAB/	807897
BC35V 12 F /MO AE EDO RVPAB/	807898
BC35V 24 F /MO AE EDO RVPAB/	807899

BC35V 12 G /MO AE EDO VLAB/	807900
BC35V 24 G /MO AE EDO VLAB/	807901
BC35V 12 F /MO AE EDO VLAB/	807902
BC35V 24 F /MO AE EDO VLAB/	807903

VL valves on ports A and B are type U.
Standard setting 140 bar.

BC35S 12 G /MO BE EDO/	807889
BC35S 24 G /MO BE EDO/	807890
BC35S 12 F /MO BE EDO/	807891
BC35S 24 F /MO BE EDO/	807892

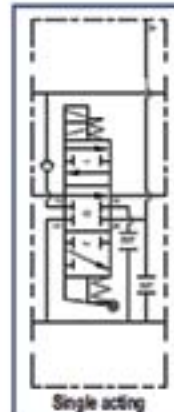
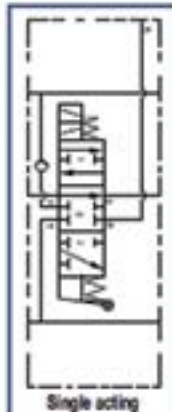

BC35V 12 G /MO BE EDO RVPAB/	807904
BC35V 24 G /MO BE EDO RVPAB/	807905
BC35V 12 F /MO BE EDO RVPAB/	807906
BC35V 24 F /MO BE EDO RVPAB/	807907

BC35V 12 G /MO BE EDO VLAB/	807908
BC35V 24 G /MO BE EDO VLAB/	807909
BC35V 12 F /MO BE EDO VLAB/	807910
BC35V 24 F /MO BE EDO VLAB/	807911

VL valves on ports A and B are type U.
Standard setting 140 bar.

BC35S 12 G /MO DE EDO/	807893
BC35S 24 G /MO DE EDO/	807894
BC35S 12 F /MO DE EDO/	807895
BC35S 24 F /MO DE EDO/	807896

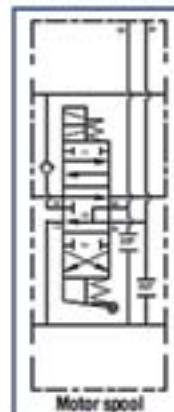
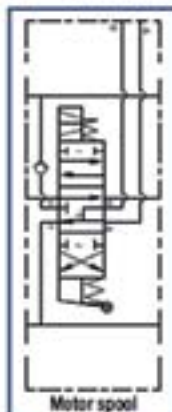

BC35V 12 G /MO DE EDO RVPAB/	807912
BC35V 24 G /MO DE EDO RVPAB/	807913
BC35V 12 F /MO DE EDO RVPAB/	807914
BC35V 24 F /MO DE EDO RVPAB/	807915

BC35V 12 G /MO DE EDO VLAB/	807916
BC35V 24 G /MO DE EDO VLAB/	807917
BC35V 12 F /MO DE EDO VLAB/	807918
BC35V 24 F /MO DE EDO VLAB/	807919

VL valves on ports A and B are type U.
Standard setting 140 bar.

BC35

Dual operation.. lever and electric solenoid valve

Flow Control built in elements



CF and CFV elements integrate a pressure compensated flow control that allows the external regulation of the flow inside the elements themselves and recuperates the exceeding flow (EF) for the following elements.

BC35CF 12 G /MO AE EDO/	807920
BC35CF 24 G /MO AE EDO/	807921
BC35CF 12 F /MO AE EDO/	807922
BC35CF 24 F /MO AE EDO/	807923

BC35CF 12 G /MO BE EDO/	807924
BC35CF 24 G /MO BE EDO/	807925
BC35CF 12 F /MO BE EDO/	807926
BC35CF 24 F /MO BE EDO/	807927

BC35CF 12 G /MO DE EDO/	807928
BC35CF 24 G /MO DE EDO/	807929
BC35CF 12 F /MO DE EDO/	807930
BC35CF 24 F /MO DE EDO/	807931

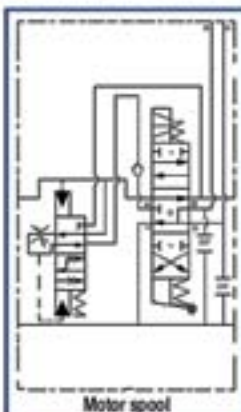
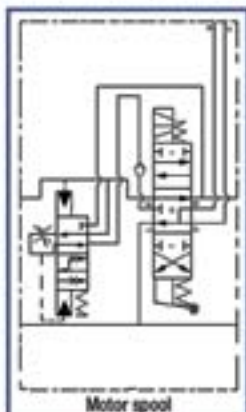
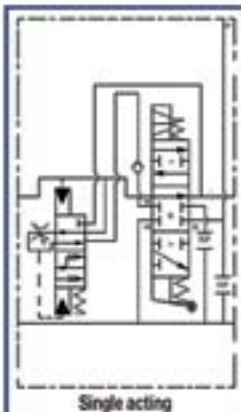
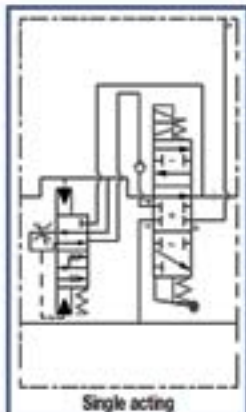
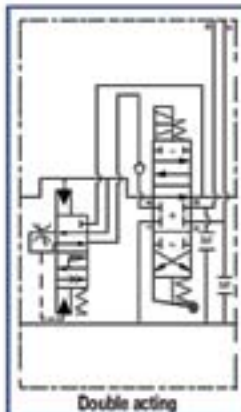
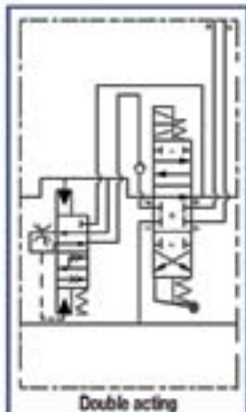

BC35CFV 12 G /MO AE EDO RVPAB/	807932
BC35CFV 24 G /MO AE EDO RVPAB/	807933
BC35CFV 12 F /MO AE EDO RVPAB/	807934
BC35CFV 24 F /MO AE EDO RVPAB/	807935

BC35CFV 12 G /MO AE EDO VLAB/	807936
BC35CFV 24 G /MO AE EDO VLAB/	807937
BC35CFV 12 F /MO AE EDO VLAB/	807938
BC35CFV 24 F /MO AE EDO VLAB/	807939

VL valves on ports A and B are type U. Standard setting 140 bar.

BC35CFV 12 G /MO BE EDO RVPAB/	807940
BC35CFV 24 G /MO BE EDO RVPAB/	807941
BC35CFV 12 F /MO BE EDO RVPAB/	807942
BC35CFV 24 F /MO BE EDO RVPAB/	807943

BC35CFV 12 G /MO BE EDO VLAB/	807944
BC35CFV 24 G /MO BE EDO VLAB/	807945
BC35CFV 12 F /MO BE EDO VLAB/	807946
BC35CFV 24 F /MO BE EDO VLAB/	807947

VL valves on ports A and B are type U. Standard setting 140 bar.

BC35CFV 12 G /MO DE EDO RVPAB/	807948
BC35CFV 24 G /MO DE EDO RVPAB/	807949
BC35CFV 12 F /MO DE EDO RVPAB/	807950
BC35CFV 24 F /MO DE EDO RVPAB/	807951

BC35CFV 12 G /MO DE EDO VLAB/	807952
BC35CFV 24 G /MO DE EDO VLAB/	807953
BC35CFV 12 F /MO DE EDO VLAB/	807954
BC35CFV 24 F /MO DE EDO VLAB/	807955

VL valves on ports A and B are type U. Standard setting 140 bar.

NOTE: After a CF or CFV the first element must be a R type

BC35

Dual operation.. lever and electric solenoid valve

Flow control elements, RFS



The pressure compensated flow control section **RFS**, divides the flow in two channels: the priority flow (**PF**) channel, adjustable with the external knob, and the exceeding flow (**EF**) channel that goes to tank. Elements preceding **RFS** sections receive the full pump flow whereas the elements following **RFS** sections receive just the flow requested and settled. In order to prevent undesired heating in the system, the **RFS** section works only when one or more of the following sections are operated. The **RFS** section can be combined with all standard elements.

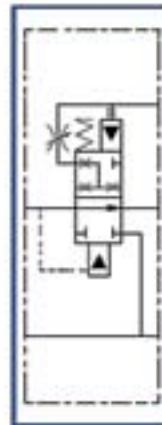

BC35 RFS	835078
BC35 RFSO	835081

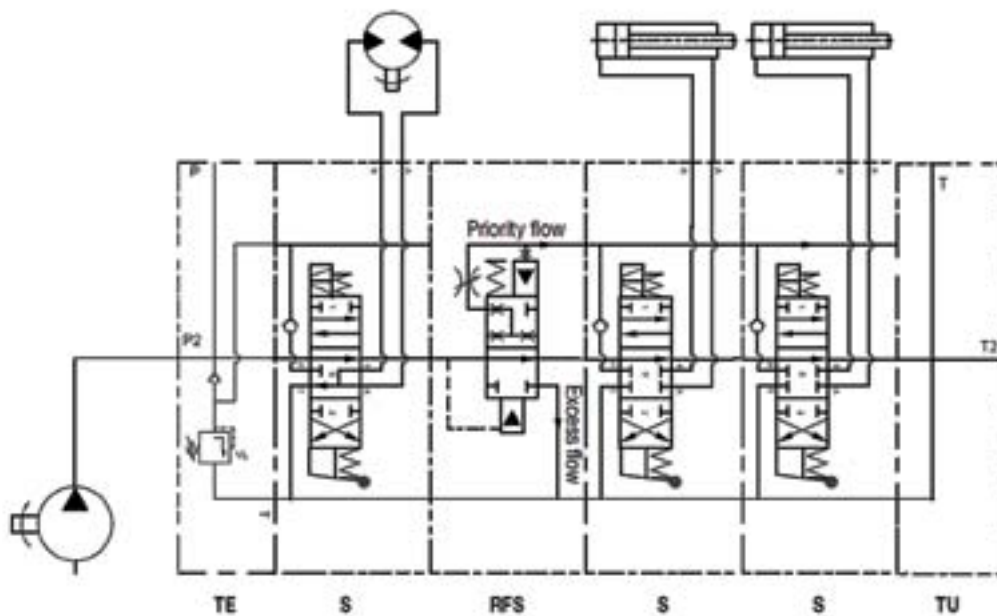

EXAMPLE The motor (A) is fed by the whole flow of the pump. The cylinders (C, D) downstream the flow control element (RFS) are fed only by the priority flow (PF) which is adjustable through the flow control knob on the element. The excess flow goes to tank.

Flow control elements, RFP



The pressure compensated flow control section **RFP**, divides the flow in two channels: the first channel receives the priority flow (**PF**) (adjustable with the external knob) and feeds one or more Priority elements (**P**, **PV**); the second channel receives the exceeding flow (**EF**) and feeds one or more Recuperation elements (**R**, **RV**) which follow the priority ones. **RFP** sections, have to be followed by one or more priority elements (**P**, **PV**); Priority elements have to be followed by one or more Recuperation elements (**R**, **RV**). In order to prevent undesired heating in the system the **RFP** section works only when one or more of the Priority sections are operated. The installation of an **RFP** section, allows the contemporaneous operation of one Priority element and one Recuperation element which will work at different flows and pressures without interfering one with the other. When no Priority section is operated, the Recuperation elements get the full pump flow.

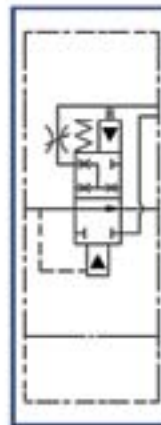

BC35 RFP	835079
BC35 RFPO	835122

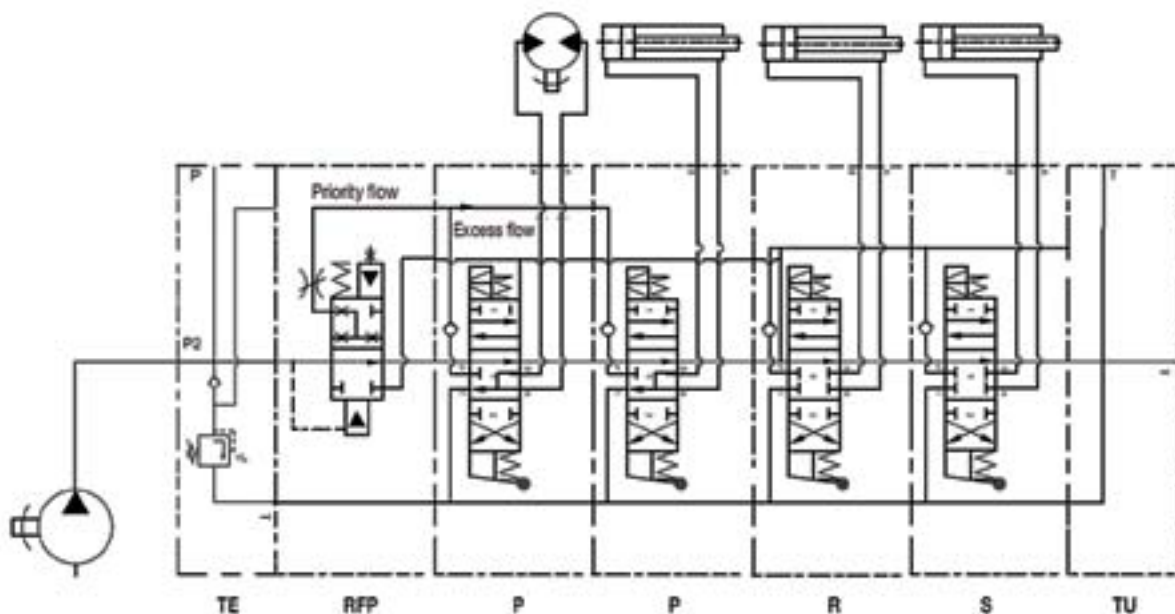

EXAMPLE The motors (A, B) are fed by the priority flow (PF) which is adjustable through the flow control knob on the element. The cylinders (C, D) are fed by the whole flow of the pump when singly actuated. When a cylinder and a motor are simultaneously actuated, the motor is fed by the priority flow (PF) and the cylinder by the exceeding flow (EF). If a cylinder is actuated while a motor is in work, this last will not vary its rotation speed.

BC35

Dual operation.. lever and electric solenoid valve

Special priority flow elements



P elements use the priority flow regulated by the RFP sections. They have to be installed after an RFP section.

BC35P 12 G /MO AE EDO/	807956
BC35P 24 G /MO AE EDO/	807957
BC35P 12 F /MO AE EDO/	807958
BC35P 24 F /MO AE EDO/	807959

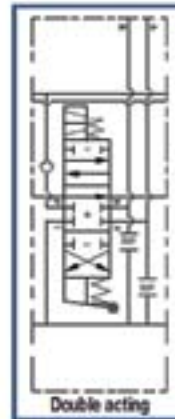
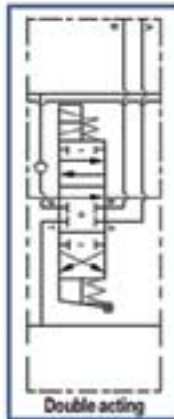

BC35PV 12 G /MO AE EDO RVPAB/	807968
BC35PV 24 G /MO AE EDO RVPAB/	807969
BC35PV 12 F /MO AE EDO RVPAB/	807970
BC35PV 24 F /MO AE EDO RVPAB/	807971

BC35PV 12 G /MO AE EDO VLAB/	807972
BC35PV 24 G /MO AE EDO VLAB/	807973
BC35PV 12 F /MO AE EDO VLAB/	807974
BC35PV 24 F /MO AE EDO VLAB/	807975

VL valves on ports A and B are type U.
Standard setting 140 bar.

BC35P 12 G /MO BE EDO/	807960
BC35P 24 G /MO BE EDO/	807961
BC35P 12 F /MO BE EDO/	807962
BC35P 24 F /MO BE EDO/	807963

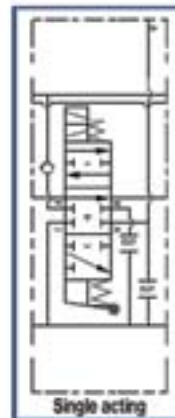
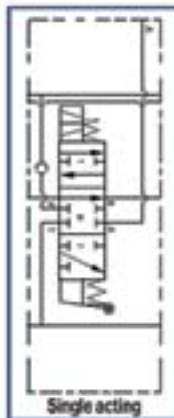

BC35PV 12 G /MO BE EDO RVPAB/	807976
BC35PV 24 G /MO BE EDO RVPAB/	807977
BC35PV 12 F /MO BE EDO RVPAB/	807978
BC35PV 24 F /MO BE EDO RVPAB/	807979

BC35PV 12 G /MO BE EDO VLAB/	807980
BC35PV 24 G /MO BE EDO VLAB/	807981
BC35PV 12 F /MO BE EDO VLAB/	807982
BC35PV 24 F /MO BE EDO VLAB/	807983

VL valves on ports A and B are type U.
Standard setting 140 bar.

BC35P 12 G /MO DE EDO/	807964
BC35P 24 G /MO DE EDO/	807965
BC35P 12 F /MO DE EDO/	807966
BC35P 24 F /MO DE EDO/	807967

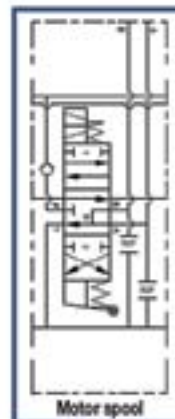
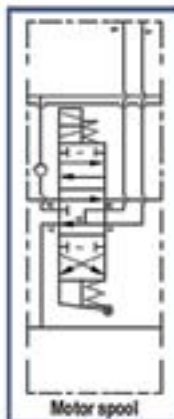

BC35PV 12 G /MO DE EDO RVPAB/	807984
BC35PV 24 G /MO DE EDO RVPAB/	807985
BC35PV 12 F /MO DE EDO RVPAB/	807986
BC35PV 24 F /MO DE EDO RVPAB/	807987

BC35PV 12 G /MO DE EDO VLAB/	807988
BC35PV 24 G /MO DE EDO VLAB/	807989
BC35PV 12 F /MO DE EDO VLAB/	807990
BC35PV 24 F /MO DE EDO VLAB/	807991

VL valves on ports A and B are type U.
Standard setting 140 bar.

Flow recuperation elements



R elements use the exceeding flow coming from an RFP section. They have to be installed only after one or more P elements.

BC35R 12 G /MO AE EDO/	807992
BC35R 24 G /MO AE EDO/	807993
BC35R 12 F /MO AE EDO/	807994
BC35R 24 F /MO AE EDO/	807995

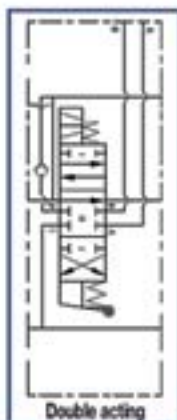

BC35RV 12 G /MO AE EDO RVPAB/	808005
BC35RV 24 G /MO AE EDO RVPAB/	808006
BC35RV 12 F /MO AE EDO RVPAB/	808007
BC35RV 24 F /MO AE EDO RVPAB/	808008

BC35RV 12 G /MO AE EDO VLAB/	808009
BC35RV 24 G /MO AE EDO VLAB/	808010
BC35RV 12 F /MO AE EDO VLAB/	808011
BC35RV 24 F /MO AE EDO VLAB/	808012

VL valves on ports A and B are type U.
Standard setting 140 bar.

BC35R 12 G /MO BE EDO/	807996
BC35R 24 G /MO BE EDO/	807997
BC35R 12 F /MO BE EDO/	807998
BC35R 24 F /MO BE EDO/	807999

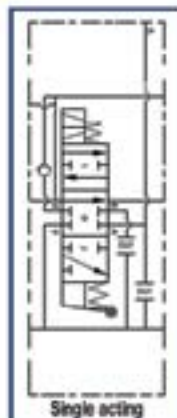
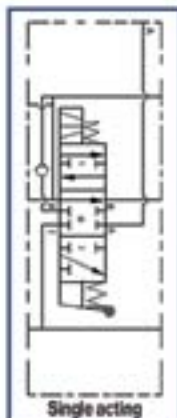

BC35RV 12 G /MO BE EDO RVPAB/	808013
BC35RV 24 G /MO BE EDO RVPAB/	808014
BC35RV 12 F /MO BE EDO RVPAB/	808015
BC35RV 24 F /MO BE EDO RVPAB/	808016

BC35RV 12 G /MO BE EDO VLAB/	808017
BC35RV 24 G /MO BE EDO VLAB/	808018
BC35RV 12 F /MO BE EDO VLAB/	808019
BC35RV 24 F /MO BE EDO VLAB/	808020

VL valves on ports A and B are type U.
Standard setting 140 bar.

BC35R 12 G /MO DE EDO/	808001
BC35R 24 G /MO DE EDO/	808002
BC35R 12 F /MO DE EDO/	808003
BC35R 24 F /MO DE EDO/	808004

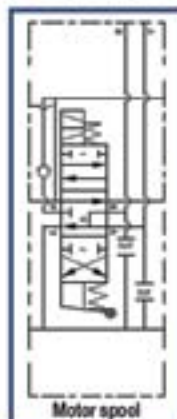
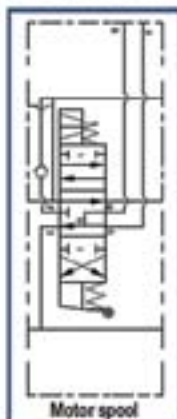

BC35RV 12 G /MO DE EDO RVPAB/	808021
BC35RV 24 G /MO DE EDO RVPAB/	808022
BC35RV 12 F /MO DE EDO RVPAB/	808023
BC35RV 24 F /MO DE EDO RVPAB/	808024

BC35RV 12 G /MO DE EDO VLAB/	808025
BC35RV 24 G /MO DE EDO VLAB/	808026
BC35RV 12 F /MO DE EDO VLAB/	808027
BC35RV 24 F /MO DE EDO VLAB/	808028

VL valves on ports A and B are type U.
Standard setting 140 bar.

BC35

Dual operation.. lever and electric solenoid valve

Outlet covers

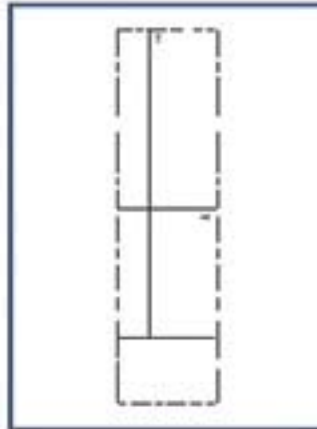

BC35TU G	805028
BC35TU F	805025

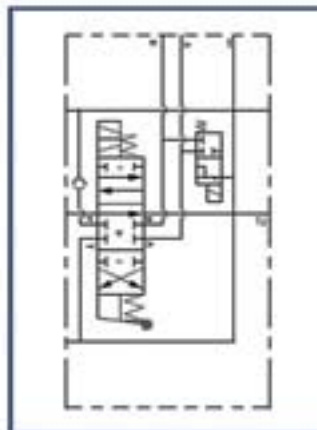

BC35TU 12 KE0 G	805134
BC35TU 24 KE0 G	805184
BC35TU 12 KE0 F	805185
BC35TU 24 KE0 F	805186

BC35TE KE0 outlet features an electric 3 ways valve. Connected to a special element, this valve, when operated, connects A and B ports to tank, allowing a cylinder or a motor to float.



Electric controls

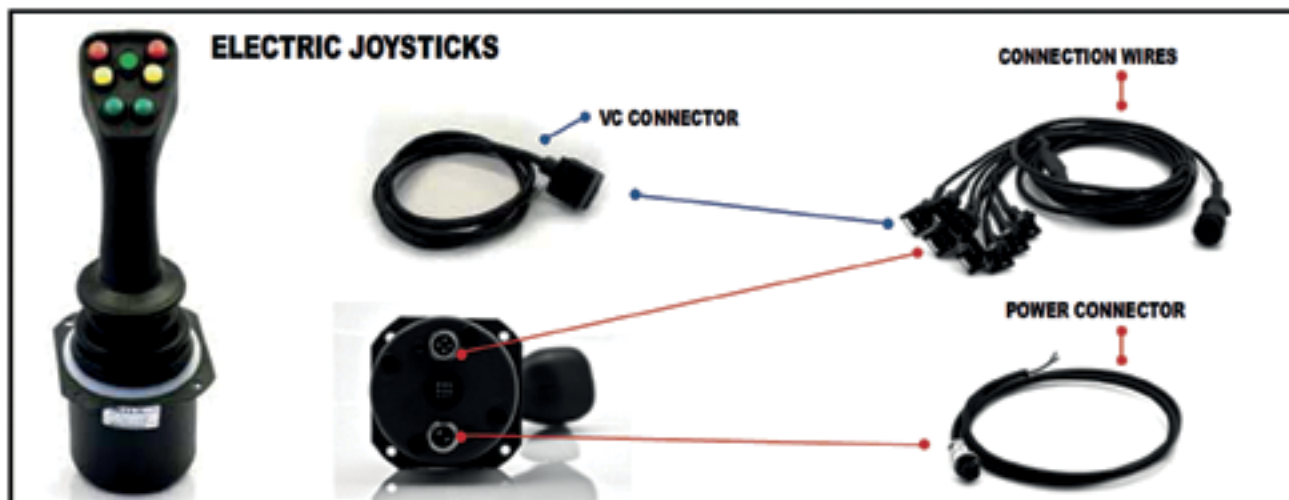

ELECTRIC JOYSTICK WITH 1 AXIS AND MICROSWITCHES

1 axis version for the control of one element in the BC35 valve. On request, extra microswitches will be available for the operation of further elements (up to 10 switches).

JME 2S	023065
JME 4S	023066
JME 6S	023067
JME 8S	023068
JME 10S	023069



ELECTRIC JOYSTICK WITH 2 AXIS AND MICROSWITCHES

2 axes version for the control of two elements in the BC35 valve. On request, extra microswitches will be available for the operation of further elements (up to 10 switches).

JSE 2S	023062
JSE 4S	023063
JSE 6S	023061
JSE 8S	023060
JSE 10S	023064



ELECTRIC PROPORTIONAL JOYSTICK WITH 1 AXIS

Electric proportional joystick complete with electronic card. 1 axis version for the control of the TE RFPE DV Inlet. On request, extra microswitches will be available for the operation of further elements (up to 10 switches).

JMP 2S	023110
JMP 4S	023111
JMP 6S	023112
JMP 8S	023113
JMP 10S	023114



VCC CONNECTION WIRES

Electric wires to connect the joystick to the valve. Standard length 4.50 meters.

VCC E2S	025105
VCC E4S	025106
VCC E6S	025107
VCC E8S	025108
VCC E10S	025109



PC POWER CONNECTOR

Connects the joystick to the power source. Standard length 4.50 meters.

PC	025110
----	--------



VC CONNECTOR

Valve connector that allows kinds of wiring different from the usual.

VC	025045
----	--------

BC35

Dual operation.. lever and electric solenoid valve

Options

CO CARRY OVER Allows the installation of another valve downstream from the first. To be assembled on T2 port of the valve.

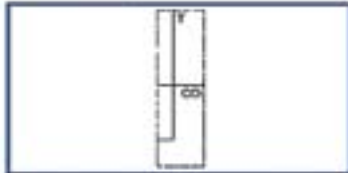

CO G	832019
CO F	832032

CCP CLOSE CENTER PLUG Turns an open center circuit into a close center one.

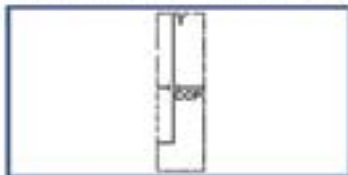

CCP G	832017
CCP F	832033

RVP RELIEF VALVE PLUG Replaces the relief valve in close center systems where the relief valve is not required.



RVP	832018
------------	--------

PB RELIEF VALVE LOCK KIT Prevents users from altering the factory relief valve setting.



PB	560926
-----------	--------

BRACKETS KIT



BRACKETS	560893
-----------------	--------

TIE RODS KIT FOR STANDARD TE

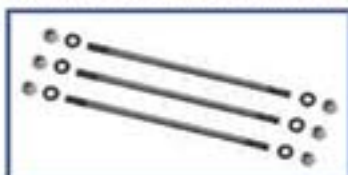

BC35/1	560062
BC35/2	560063
BC35/3	560064
BC35/4	560065
BC35/5	560066

BC35/6	560067
BC35/7	560207
BC35/8	560208
BC35/9	560209
BC35/10	560210

TIE RODS KIT FOR TE DV - TE RFPE DV

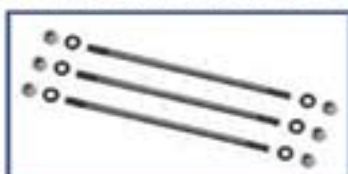

BC35/1	560960
BC35/2	560961
BC35/3	560962
BC35/4	560963
BC35/5	560964

BC35/6	560965
BC35/7	560966
BC35/8	560967
BC35/9	560968
BC35/10	560969

Ordering code

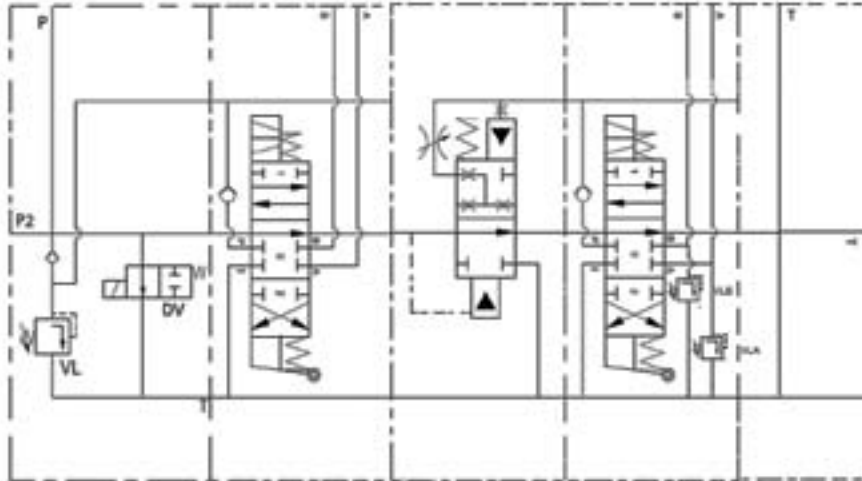

BC35 / 3 12 DV GK / S MO AE EDO / RFS / V MO AE EDO VLAB / CO

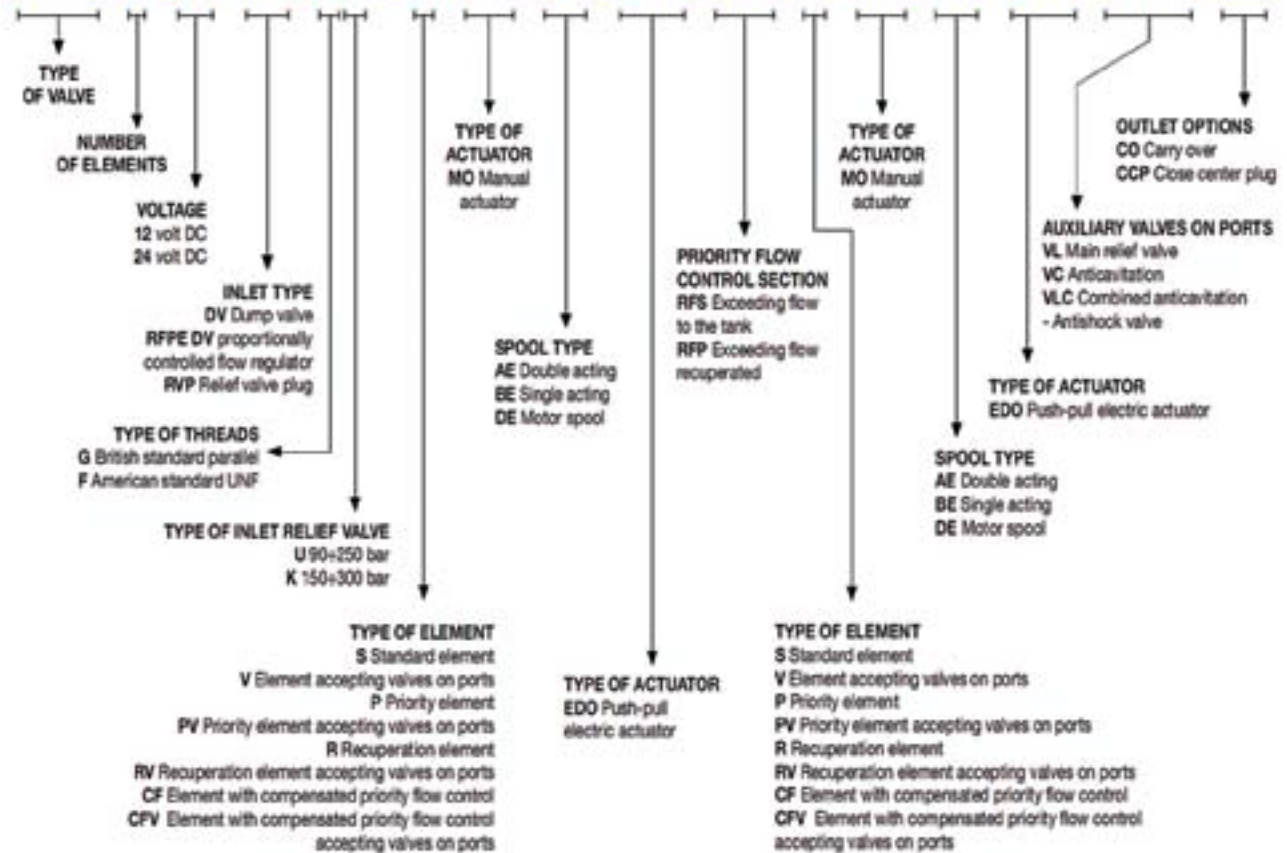

LEGEND

A Port	DV Dump valve	VLAB Antishock valves	CCP Close center plug
B Port	DVP Dump valve plug	VLC Antishock and anticavitation valve	CO Carry over
P Pump connection	EDO Push-pull electric actuator	VC Anticavitation valve	
P2 Pump connection	MO Manual actuator	T Tank connection	 MANDATORY FIELD
RVP Relief valve plug	VL Main relief valve	T2 Tank connection	 OPTIONAL FIELD