

MRF8

Blanking plate
CETOP 8 / NG25

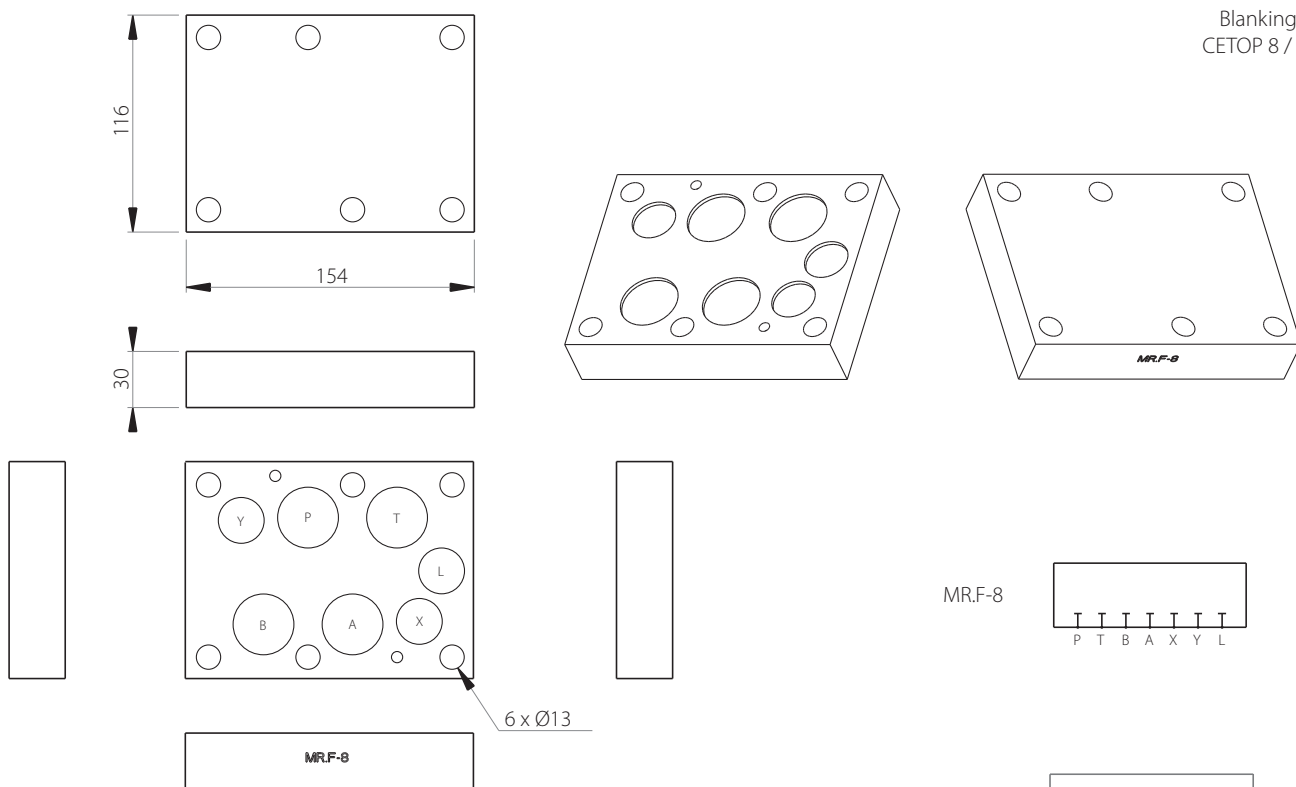

Technical specifications	
Material	Steel-Phosphating
Pressure	400 bar max
Weight	4.30 kg
Supplied with seals and screws	

