

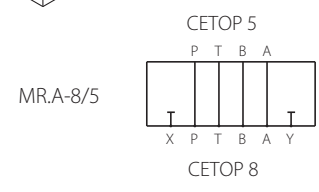

MRA-8/5

Adaptor plate Cetop 5 to Cetop 8
CETOP8 / NG25

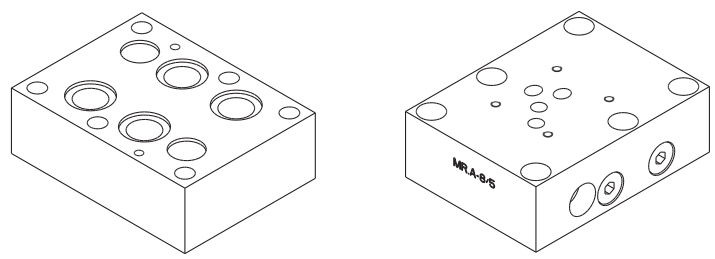
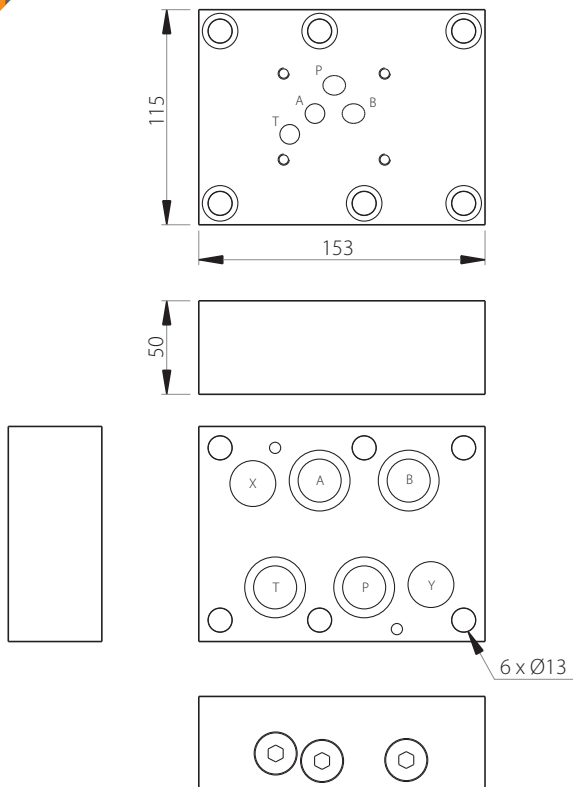

Technical specifications	
Material	Steel-Phosphating
Pressure	400 bar max
Weight	5.70 kg
Supplied with seals and screws	