

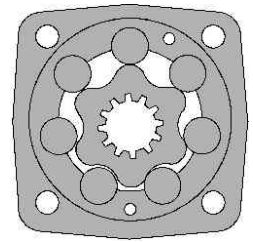

The gear set of the MAS(E) motor is consisted of rotor, stator and rollers which can increase motor performance and efficiency. Feature tapered roller bearing on the output shaft, which allows for the motors to sustain very high radial and axial loads. MAS(E) motor incorporate an advanced valving design that allows the high pressure flow to be better isolated from the low pressure flow within the motor.



## Specifications

TYPE		MAS(E) 80	MAS(E) 100	MAS(E) 125	MAS(E) 160	MAS(E) 200	MAS(E) 250	MAS(E) 315	MAS(E) 400
Displacement (c.c/rev)		80.8	99.8	125.2	159.5	200	252.3	315.1	397
Max. speed (rpm)	Cont	805	746	598	465	373	298	236	187
	Int(3)	1000	900	718	560	447	360	290	230
Max. Torque (da Nm)	Cont	19.8	24.4	30.7	34.0	39.5	45.0	54.1	58
	Int(3)	23.7	29.3	36.8	46.9	49.0	53.5	63	69
	Peak(4)	26.0	32.2	40.5	48.5	64.8	68.2	84	85
Max. output (Kw)	Cont	16.4	19.4	20	12	14	13.6	11.5	10
	Int(3)	22	26	24	21.8	21	21.2	13.5	13
Max. pressure drop (bar)	Cont	175	175	175	160	150	140	120	100
	Int(3)	210	210	210	210	180	175	140	120
	Peak(4)	225	225	225	225	225	200	185	140
Max.oil flow (l/min)	Cont	65	75	75	75	75	75	75	75
	Int(3)	80	90	90	90	90	90	90	90
Max. Inlet pressure (bar)	Cont	210	210	210	210	210	210	210	210
	Int(3)	250	250	250	250	250	250	250	250
	Peak(4)	300	300	300	300	300	300	300	300
Weight (kg)		10	10.3	10.5	11	11.4	11.9	12.5	13.5

(3) Intermittent operation rating applies to 6 sec. of every minute

(4) Peak load rating applies to 0.6 sec of every minute

TYPE		MAS(E) 80	MAS(E) 100	MAS(E) 125	MAS(E) 160	MAS(E) 200	MAS(E) 250	MAS(E) 315	MAS(E) 400
Displacement (in.3/r )		4.9	6.1	7.6	9.7	12.2	15.4	19.2	24.2
Max. speed (rpm)	Cont	805	746	598	465	373	298	236	187
	Int(3)	1000	900	718	560	447	360	290	230
Max. Torque (lb-in)	Cont	1751	2163	2713	3009	3496	3983	4788	5133
	Int(3)	2101	2595	3256	4148	4337	4735	5576	6107
	Peak(4)	2301	2850	3584	4292	5735	6035	7434	7523
Max. output (hp)	Cont	22	26	26.8	16.1	18.8	18.2	15.4	13.4
	Int(3)	29.5	34.9	32.2	29.2	28.2	28.4	18.1	17.4
Max. pressure drop (psi)	Cont	2540	2540	2540	2320	2175	2030	1740	1450
	Int(3)	3045	3045	3045	3045	2610	2540	2030	1740
	Peak(4)	3260	3265	3265	3265	3265	2900	2685	2030
Max.oil flow (gpm)	Cont	17.2	19.8	19.8	19.8	19.8	19.8	19.8	19.8
	Int(3)	21.2	23.8	23.8	23.8	23.8	23.8	23.8	23.8
Max. Inlet pressure (psi)	Cont	3045	3045	3045	3045	3045	3045	3045	3045
	Int(3)	3625	3625	3625	3625	3625	3625	3625	3625
	Peak(4)	4350	4350	4350	4350	4350	4350	4350	4350
Weight (lbs)		22.2	22.9	23.3	24.4	25.3	26.4	27.8	30.0

A : Continuous operation  
 B : Intermittent operation rating applies to 6 sec. of every minute.

### MAS(E)80

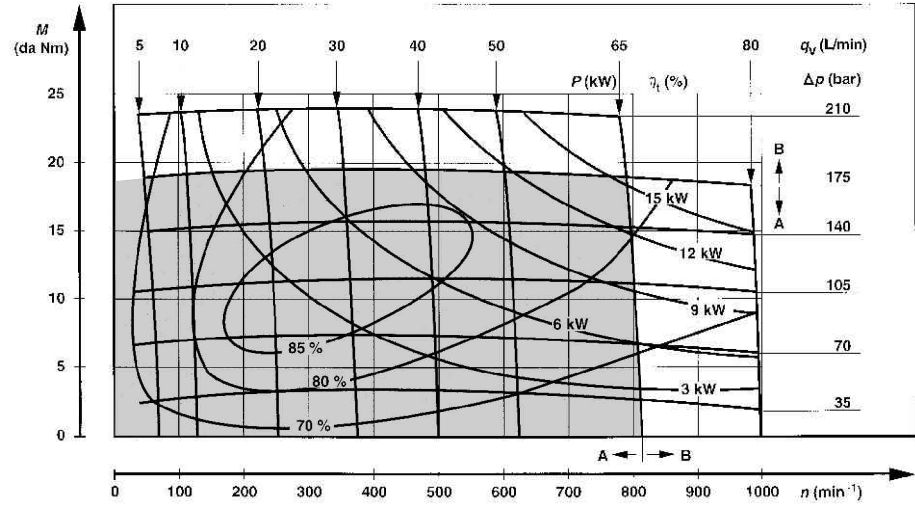

### MAS(E)100

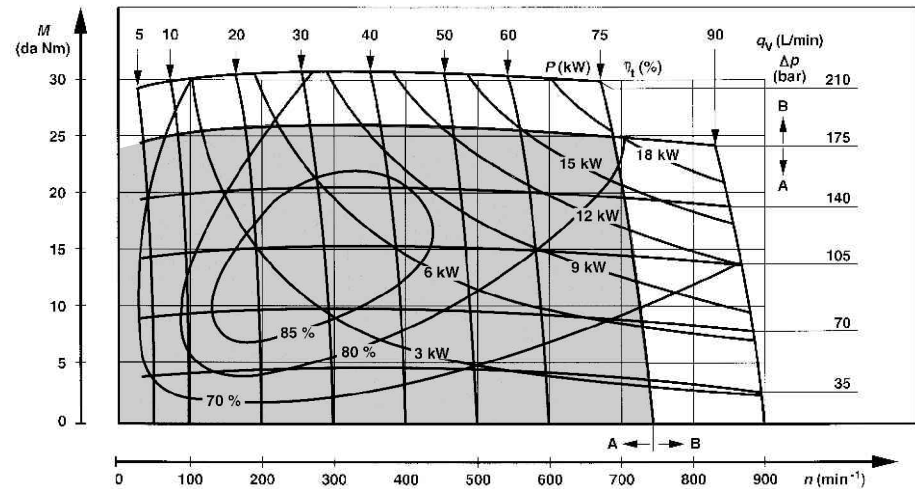

### MAS(E)125

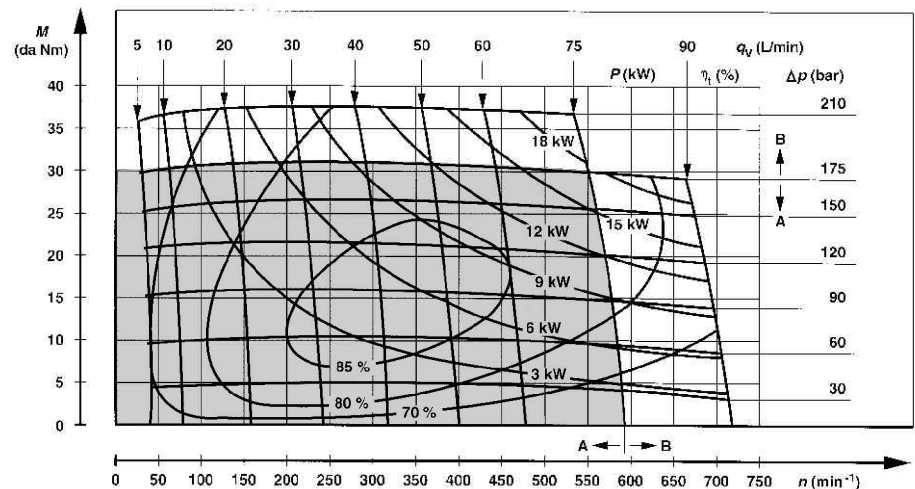

A : Continuous operation

B : Intermittent operation rating applies to 6 sec. of every minute.

MAS(E)160

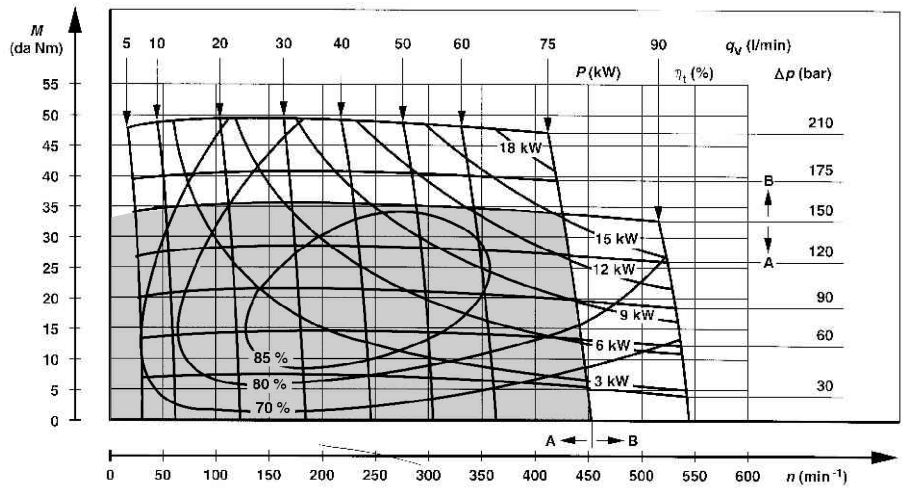

MAS(E)200

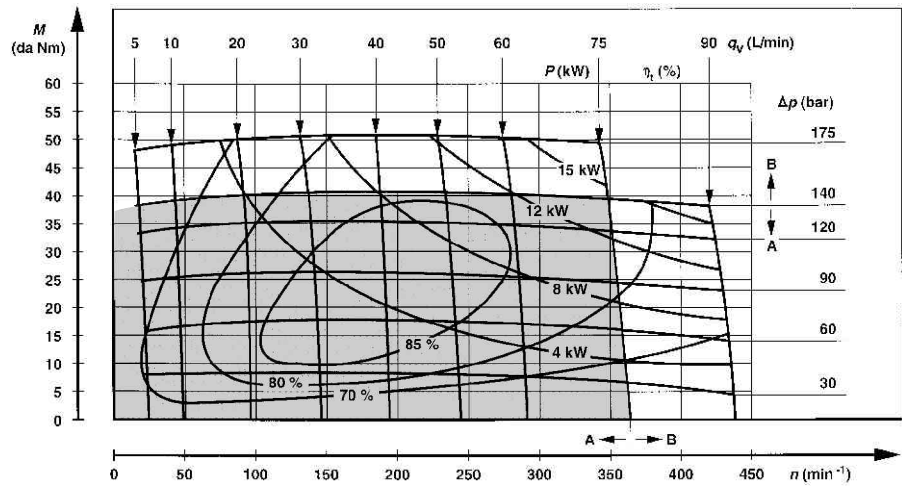

MAS(E)250

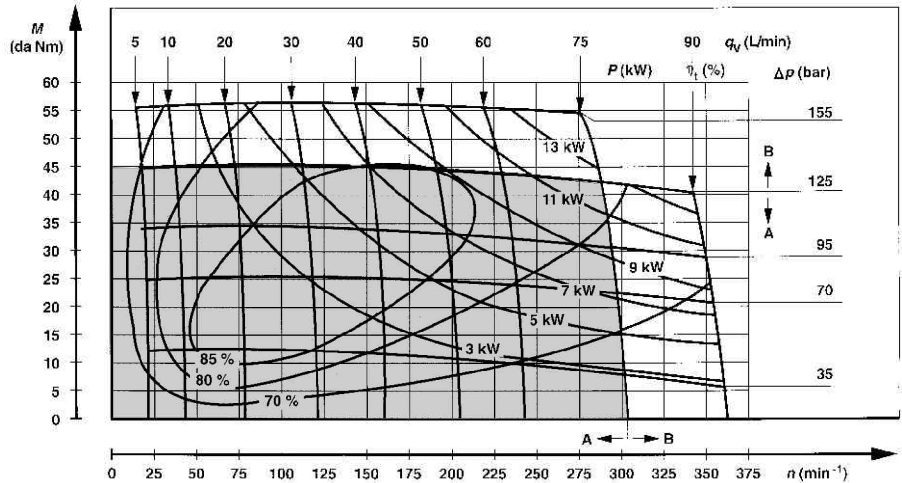

A : Continuous operation

B : Intermittent operation rating applies to 6 sec. of every minute.

MAS(E)315

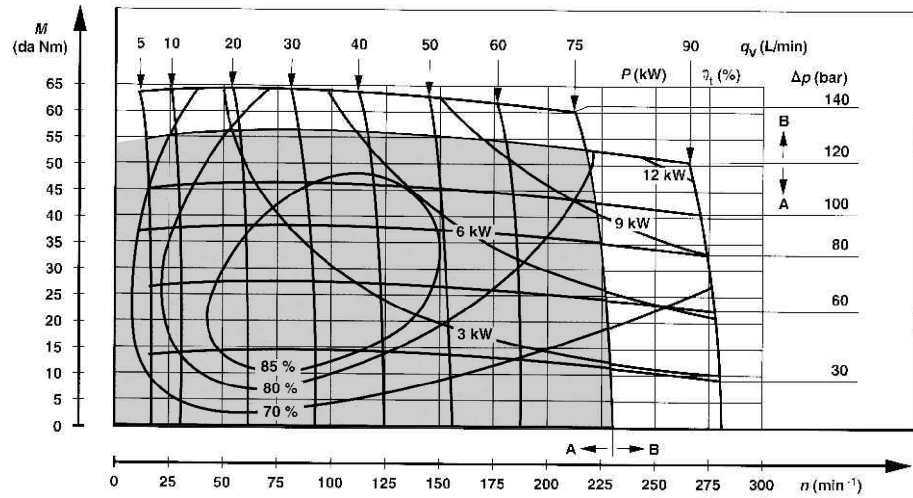

MAS(E)400

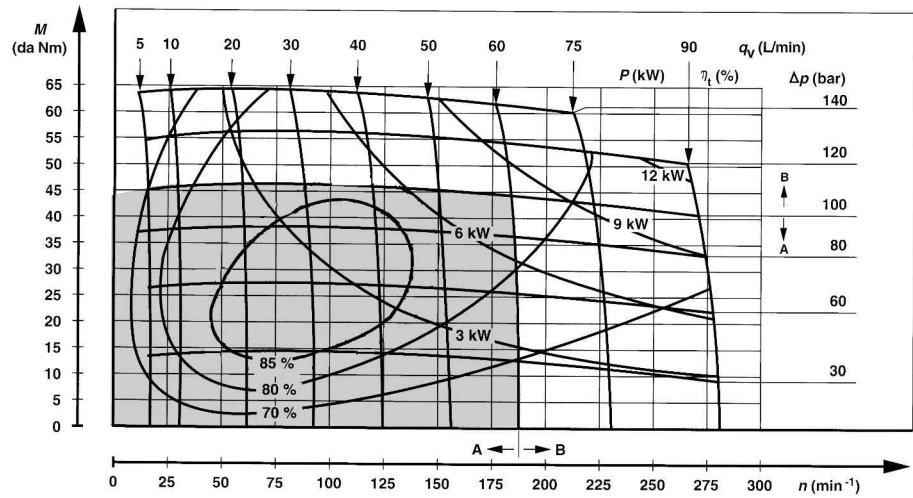

# Dimensions and Mounting Data

Code	Versions		
Port	Omit	M	U
P(A,B)	2 x G 1/2	2 x M22 x 1.5	2 x 7/8-14UNF
T	G 1/4	M14 x 1.5	7/16-20UNF
C	2 x M10	2 x M10	4 x 5/16-18UNC

## Porting

Side Ports

Versions **G M U**

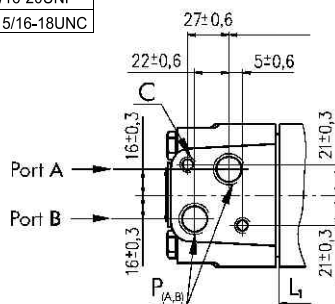

## Rear Ports

Versions **G M U**

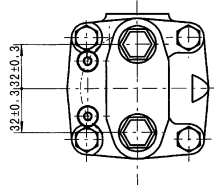

## Wheel Mounting

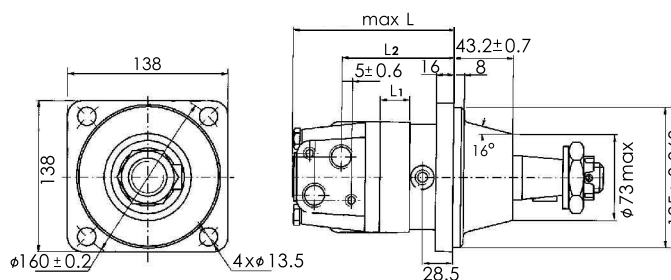

## Mounting

SAE A Mount (4 Holes)

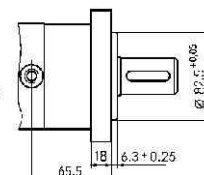
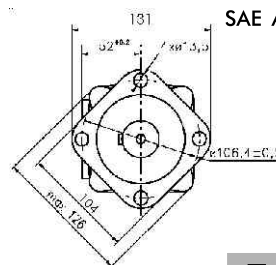

Magneto Mount (4 Holes)

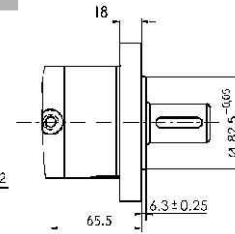
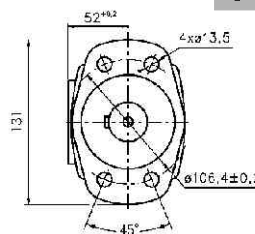

SAE A- Mount (2 Holes)

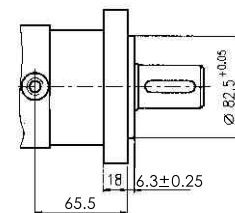
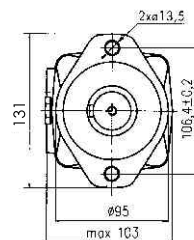

Square Mount (4 Holes)

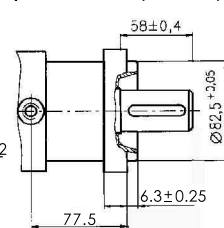
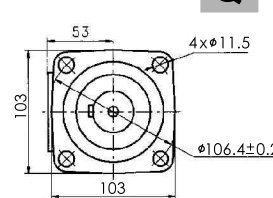

Type	L	L <sub>2</sub>	Type	L	L <sub>2</sub>	Type	L	L <sub>2</sub>	Type	L	L <sub>1</sub>
MAS(F) 80	167	123.2	MASQ 80	179	135.2	MASW 80	130	86	MASE 80	177	13
MAS(F) 100	171	127.2	MASQ 100	183	139.2	MASW 100	134	90	MASE 100	181	17
MAS(F) 125	176	132.2	MASQ 125	188	144.2	MASW 125	139	95	MASE 125	186	22
MAS(F) 160	181.5	137.7	MASQ 160	193.5	149.7	MASW 160	144.5	100.5	MASE 160	192	27.5
MAS(F) 200	189	145.2	MASQ 200	201	157.2	MASW 200	152	108	MASE 200	201	35.1
MAS(F) 250	201	157.2	MASQ 250	213	169.2	MASW 250	164	120	MASE 250	211	47
MAS(F) 315	213	169.2	MASQ 315	225	181.2	MASW 315	176	132	MASE 315	223	59
MAS(F) 400	225	181.2	MASQ 400	237	193.2	MASW 400	188	144	MASE 400	235	71

# Dimensions and Mounting Data

Type	L	L <sub>1</sub>	L <sub>2</sub>
MASS 80	130	13	86
MASS 100	134	17	90
MASS 125	139	22	95
MASS 160	144.5	27.5	100.5
MASS 200	152	35.1	108
MASS 250	164	47	120
MASS 315	176	59	132
MASS 400	188	71	144

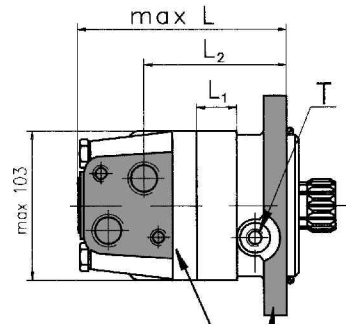

## Porting

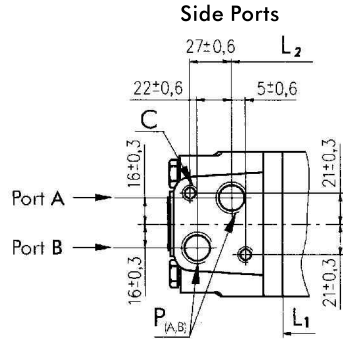

Code	Versions		
	Omit	M	U
P <sub>(A,B)</sub>	2 x G 1/2	2 x M22 x 1.5	2 x 7/8-14UNF
T	G 1/4	M14 x 1.5	7/16-20UNF
C	2 x M10	2 x M10	4 x 5/16-18UNC

## Mounting

### S Short Mount

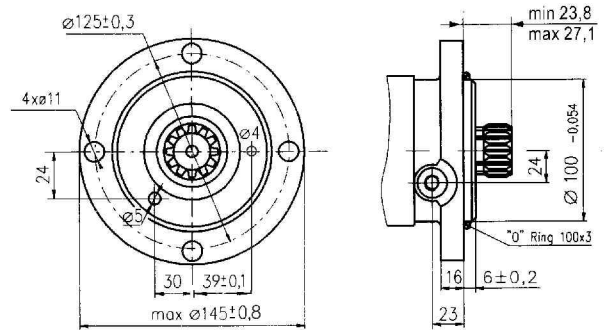

## Technical

The short motor has no output shaft or bearings. It is designed for direct mounting onto a gearbox that already has its female input shaft in bearings.

The cardan shaft of the short motor describes a tumbling motion. Consequently, the motor itself cannot be fitted with a shaft seal. The add-on component (gearbox) must be fitted with a leakage oil from flowing into the add-on unit.

The maximum permissible back flow pressure (pressure in the motor leakage oil line) is dependent on the loading capacity of the shaft seal. We always recommended fitting a leakage oil line.

The gearbox input must be designed so the leakage oil from the motor lubricates the cardan shaft profile and the bearings.

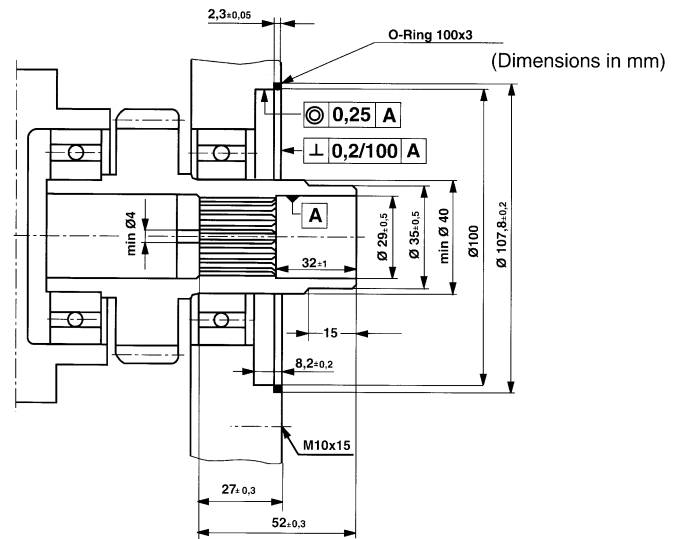

## Internal Spline Data for The Attached Component

Fillet Root Side Fit	mm
Number of Tech	z 12
Diametral Pitch	DP 12/24
Pressure Angle	30°
Pitch Dia.	D 25.4
Major Dia.	D <sub>ri</sub> 28.0 <sup>-0.1</sup>
Minor Dia.	D <sub>i</sub> 23.0 <sup>+0.033</sup>
Space Width [Circular]	L <sub>o</sub> 4.308 ± 0.020

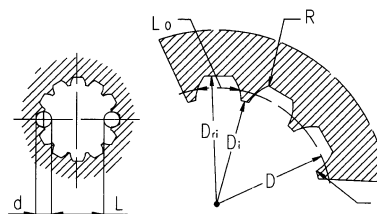

Hardening Specification:  
HRC 60 ± 2  
Effective case depth (HRC 52) 0,7 ± 0,2 mm

# Dimensions and Mounting Data

(mm) show in brackets [ ]

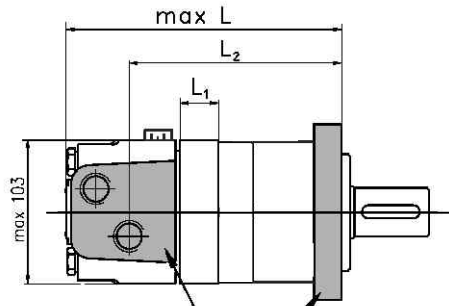

## Porting

### D Side Ports

Versions **U M G**

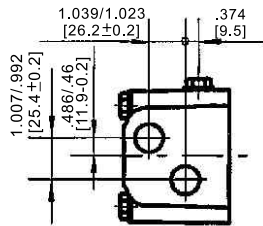

## W Wheel Mount (4 Holes)

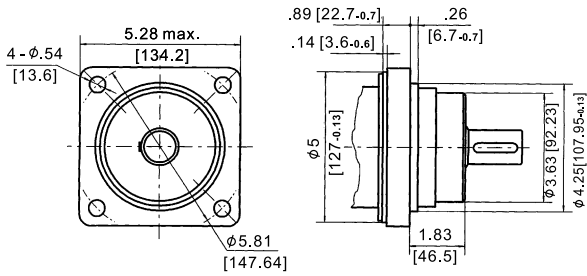

Code	Versions		
	U	M	G
P(A,B)	2 x 7/8-14UNF	2 x M22 x 1.5	2 x G 1/2
T	7/16-20UNF	M14 x 1.5	G 1/4

## Mounting

### SAE.A Mount (4 Holes)

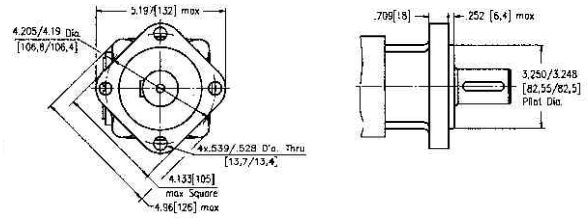

### A SAE.A Mount (2 Holes)

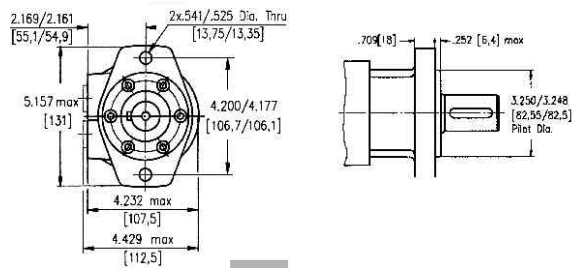

### B SAE.B Mount (2 Holes)

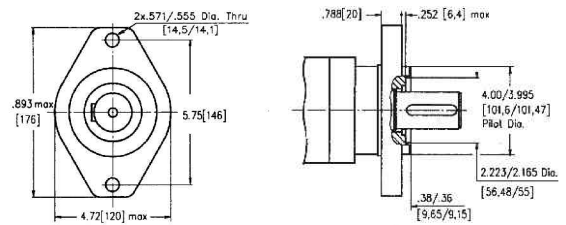

### F Magneto Mount (4 Holes)

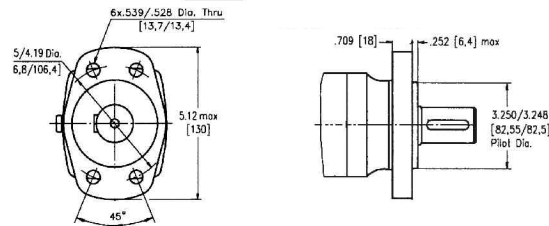

Type	L	L <sub>2</sub>	Type	L	L <sub>2</sub>	L <sub>1</sub>
MASE(F) 80	6.73 [171]	4.85 [123.2]	MASEW 80	5.63 [143]	3.74 [95]	.51 [13]
MASE(F) 100	6.89 [175]	5.01 [127.2]	MASEW 100	5.79 [147]	3.90 [99]	.67 [17]
MASE(F) 125	7.09 [180]	5.21 [132.2]	MASEW 125	5.98 [152]	4.09 [104]	.87 [22]
MASE(F) 160	7.26 [184.5]	5.42 [137.7]	MASEW 160	6.20 [157.5]	4.31 [109.5]	1.08 [27.5]
MASE(F) 200	7.60 [193]	5.72 [145.2]	MASEW 200	6.50 [165]	4.61 [117]	1.38 [35.1]
MASE(F) 250	8.07 [205]	6.19 [157.2]	MASEW 250	6.97 [177]	5.07 [129]	1.85 [47]
MASE(F) 315	8.54 [217]	6.66 [169.2]	MASEW 315	7.44 [189]	5.55 [141]	2.32 [59]
MASE(F) 400	9.02 [229]	7.13 [181.2]	MASEW 400	7.91 [201]	6.02 [153]	2.80 [71]

# Dimensions and Mounting Data

(mm) show in brackets [ ]

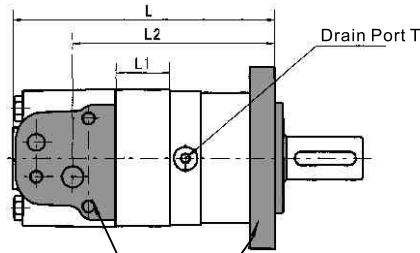

## Porting

### P Side Ports

Versions **U M G**

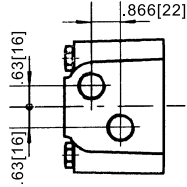

### MU Side Ports Maniflod

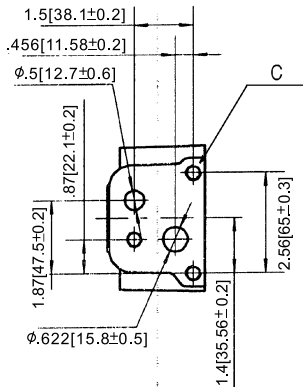

### R Rear Ports

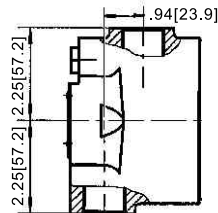

## Mounting

### SAE.A Mount (4 Holes)

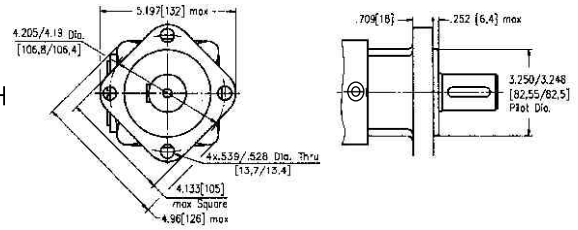

### A SAE.A Mount (2 Holes)

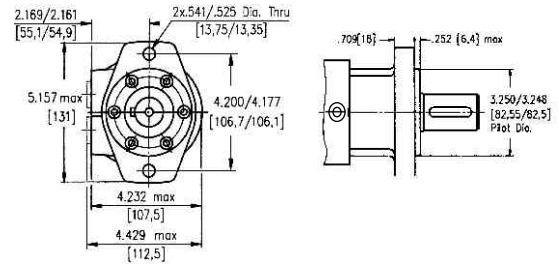

### B SAE.B Mount (2 Holes)

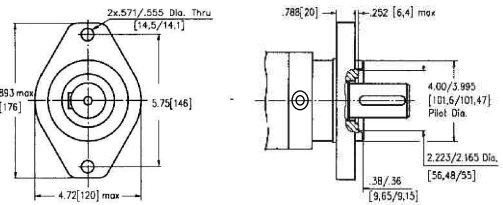

### F Magneto Mount (4 Holes)

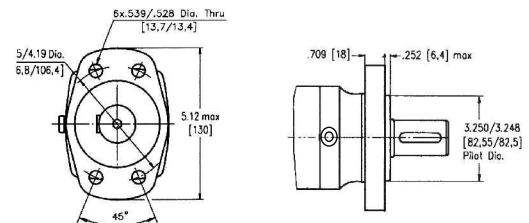

### W Wheel Mount (4 Holes)

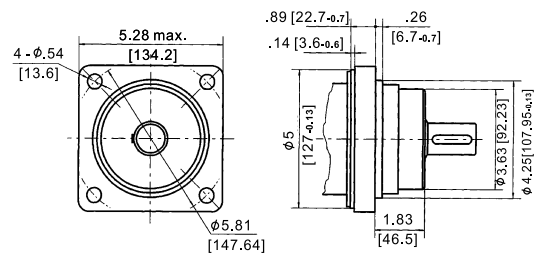

Code	Versions				
Port	U	M	G	MU	R
<b>P(A,B)</b>	2 x 7/8-14UNF	2 x M22 x 1.5	2 x G 1/2	ϕ12.7, ϕ15.8	1-1/16-12UN
<b>T</b>	7/16-20UNF	M14 x 1.5	G 1/4	7/16-20UNF	7/16-20UNF
<b>C</b>	-	-	-	3x 3/8-16UNC	-

Type	L	L <sub>2</sub>	Type	L	L <sub>2</sub>	L <sub>1</sub>
MASE(*) 80	6.57[167]	4.79[121.7]	MASE(R) 80	6.81[173]	4.95[125.7]	.51[13]
MASE(*) 100	6.73[171]	4.95[125.7]	MASE(R) 100	6.97[177]	5.11[129.7]	.67[17]
MASE(*) 125	6.93[176]	5.15[130.7]	MASE(R) 125	7.17[182]	5.30[134.7]	.87[22]
MASE(*) 160	7.15[181.5]	5.36[136.2]	MASE(R) 160	7.38[187.5]	5.52[140.2]	1.08[27.5]
MASE(*) 200	7.44[189]	5.66[143.7]	MASE(R) 200	7.68[195]	5.81[147.7]	1.38[35.1]
MASE(*) 250	7.91[201]	6.13[155.7]	MASE(R) 250	8.15[207]	6.29[159.7]	1.85[47]
MASE(*) 315	8.39[213]	6.60[167.7]	MASE(R) 315	8.62[219]	6.76[171.7]	2.32[59]
MASE(*) 400	8.86[225]	7.07[179.7]	MASE(R) 400	9.09[231]	7.23[183.7]	2.80[71]

Note: (\*) for Side Port Code MU and P



# Dimensions and Mounting Data

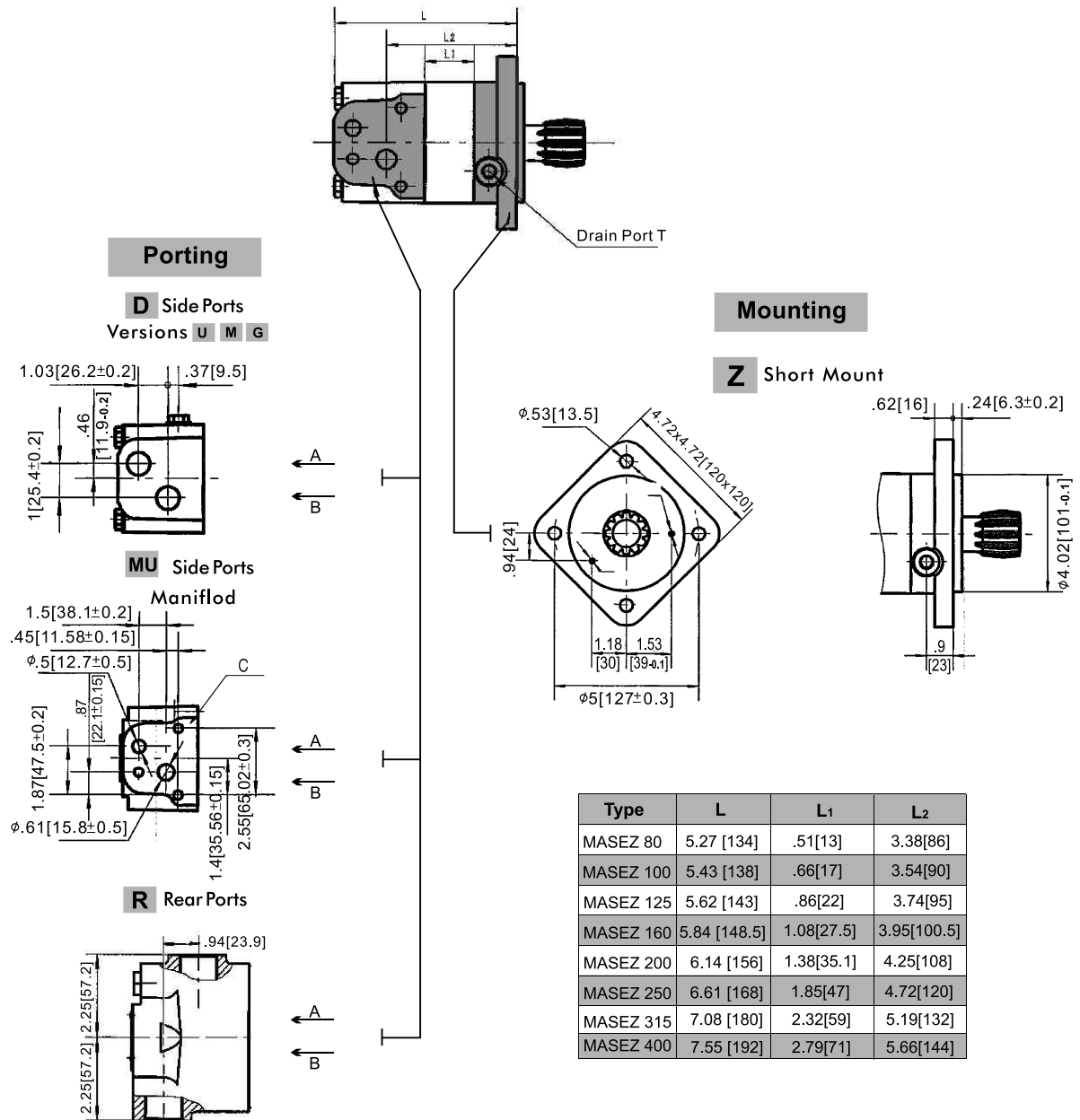

Code	Versions				
Port	U	M	G	MU	R
<b>P<sub>(A,B)</sub></b>	2 x 7/8-14UNF	2 x M22 x 1.5	2 x G 1/2	φ12.7, φ15.8	1-1/16-12UN
<b>T</b>	7/16-20UNF	M14 x 1.5	G 1/4	7/16-20UNF	7/16-20UNF
<b>C</b>	-	-	-	3x 3/8-16UNC	-

## Internal Spline Data for The Attached Component

Fillet Root Side Fit		mm
Number of Tech	z	12
Diametral Pitch	DP	12/24
Pressure Angle		30°
Pitch Dia.	D	25.4
Major Dia.	Dei	27.6 <sup>+0.14</sup>
Minor Dia.	Dii	23.1 <sup>+0.12</sup>
Space Width [Circular]	E	4.282±0.036
Dimension between two pins (φ3.38) Me		26.929-27.84

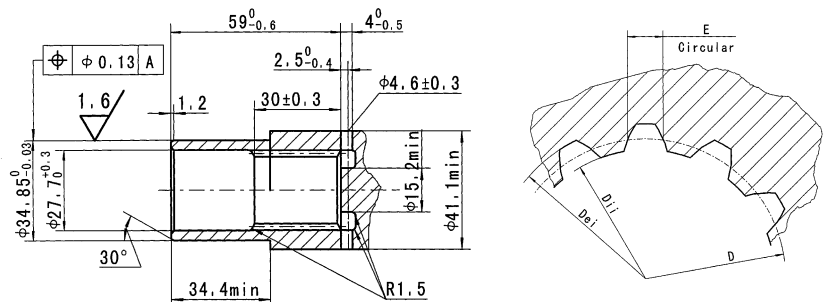

# Shaft Extensions for MAS & MASE Motor

**C**

φ32 straight, Parallel key A10x8x45  
Max. Torque 77 daNm

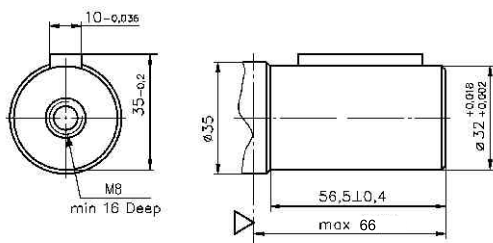

**TB**

Tapered 1:10, Parallel key B6x6x20  
Max. Torque 95 daNm

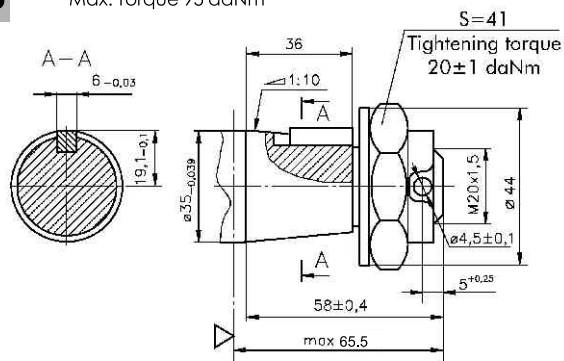

**CO**

φ 1 1/4" straight, Parallel key 5/16" x 5/16" x 1 1/4" BS46  
Max. Torque 77 daNm

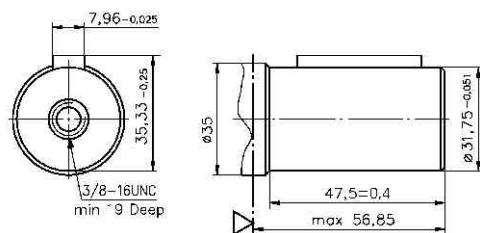

**SB**

φ 1 1/4" Splined 14T, ANSI B92.1-1976 Norm  
Max. Torque 77 daNm

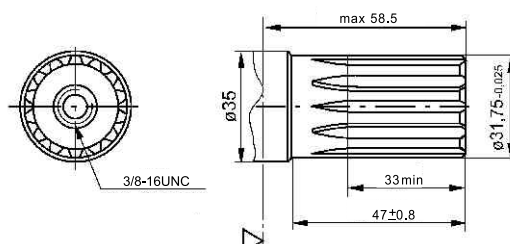

**S**

Splined, (SAE 6B)  
Max. Torque 34 daNm

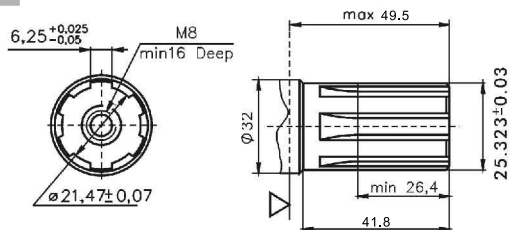

**TA**

Tapered 1:8 SAEJ 501, Parallel key 5/16" x 5/16" x 1 1/4"  
Max. Torque 77 daNm

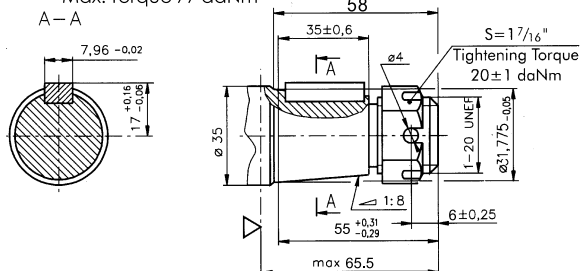

**SH**

φ 31.75 [1 1/4"] Splined 14T, DP 12/24  
Max. Torque 95 daNm

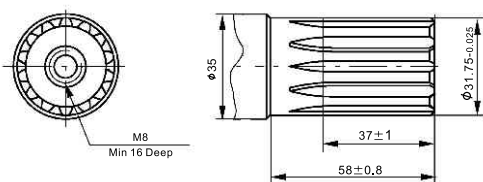

**SL**

6-34.85 P.T.O. Splined  
Max. Torque 77 daNm

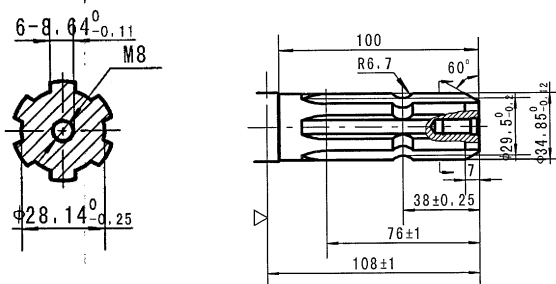

**C1**

φ25 Straight, Parallel key A8 x 7 x 32  
Max. Torque 34 daNm

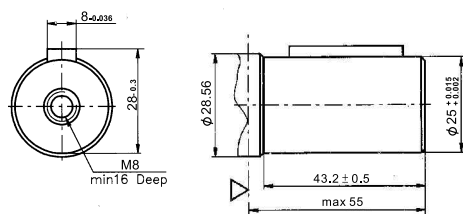

**C2**

φ 1" Straight, Parallel key 1/4" x 1/4" x 1 1/4"  
Max. Torque 34 daNm

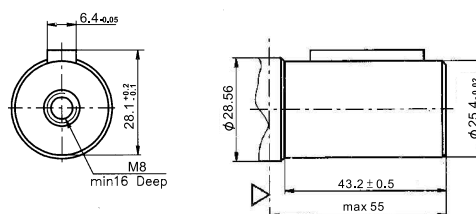

# Rotation Selection

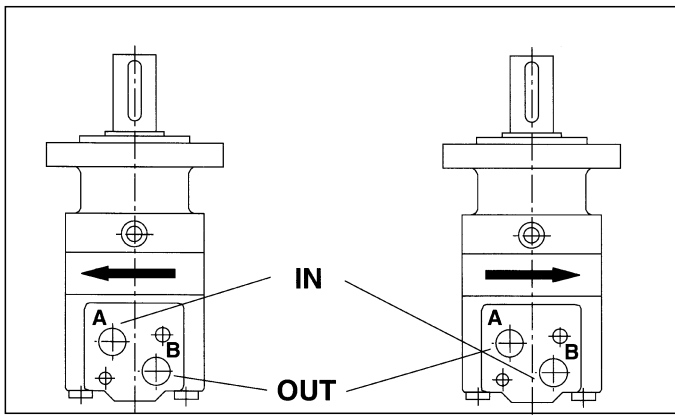

The MAS(E) has built-in check valves. The pressure on the shaft seal is never greater than back flow pressure because of the built-in check valves. In the short motor, pressure is determined based on the technical data of the add-on components.

Max. return pressure without drain line or/ Max. pressure in drain line

rpm	Cont. (bar)
0 - 100 rpm	75
100 - 300 rpm	50
300 - 810 rpm	20

Max. return pressure with drain line

Continuous	140 bar
Intermittent	175 bar

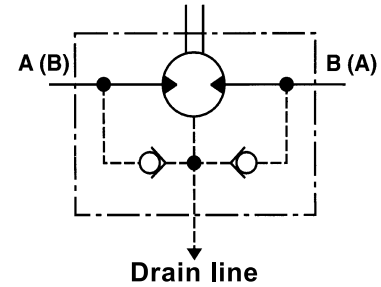

## Shaft Load

The tapered roller bearings on the output shaft mean it can accept high levels of axial and radial shaft load.

The broken curve plots the maximum permissible radial load. Loads above and beyond this level can lead to breakage. The central solid curve plot the permissible radial loads for a theoretical service life (B 10) of 3000 hours at 200 rpm. The expected service life can be calculated for different speeds and/or radial loads.

This data assumes the use of hydraulic fluid with a sufficient anti-wear additive content.

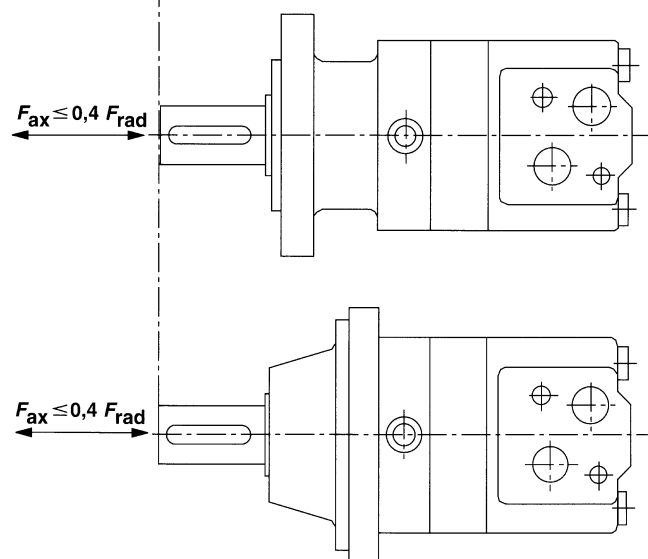
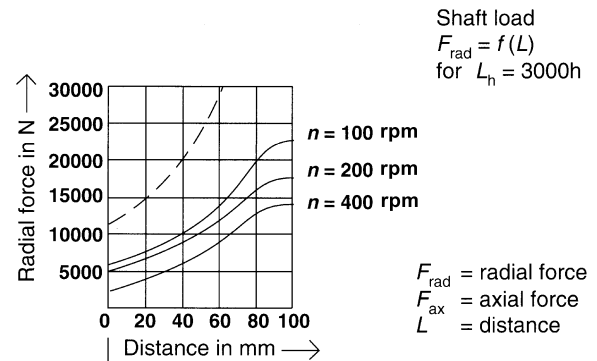

	1	2	3	4	5	6
<b>MAS</b>						

**Pos.1 Mounting Flange**

Omit - SAE. A Mount, 4 holes

- F** - Magneto Mount, 4 holes
- A** - SAE. A Mount (2 holes)
- Q** - Square Mount
- W** - Wheel Mount
- S** - Short Mount

**Pos.2 Port Type**

Omit - Side Ports

- E** - Rear Ports

**Pos.3 Displacement Code**

- 80** - 80.8cc / 4.9 [in.3/r]
- 100** - 100.9cc / 6.2 [in.3/r]
- 125** - 125.2cc / 7.6 [in.3/r]
- 160** - 159.5cc / 9.7 [in.3/r]
- 200** - 201.2cc / 12.3 [in.3/r]
- 250** - 252.3cc / 15.4 [in.3/r]
- 315** - 315.1cc / 19.2 [in.3/r]
- 400** - 397.0cc / 24.2 [in.3/r]

	1	2	3	4	5	6	7
<b>MASE</b>							

**Pos.1 Mounting Flange**

Omit - SAE. A Mount, 4 holes

- A** - Oval Mount, SAE. A (2 holes)
- F** - Magneto Mount, 4 holes
- B** - SAE. B Mount (2 holes)
- W** - Wheel Mount
- Z** - Short Mount

**Pos.2 Port Type**

- D** - Side Ports
- P** - Side Ports
- MU** - Omit
- R** - Omit

**Pos.3 Displacement Code**

- 80** - 80.8cc / 4.9 [in.3/r]
- 100** - 100.9cc / 6.2 [in.3/r]
- 125** - 125.2cc / 7.6 [in.3/r]
- 160** - 159.5cc / 9.7 [in.3/r]
- 200** - 201.2cc / 12.3 [in.3/r]
- 250** - 252.3cc / 15.4 [in.3/r]
- 315** - 315.1cc / 19.2 [in.3/r]
- 400** - 397.0cc / 24.2 [in.3/r]

**Pos.4 Shaft Extensions**

- C** -  $\phi$  32 Straight, Parallel key A10 x 8 x 45
- CO** -  $\phi$  1 1/4" Straight, Parallel key 5/16" x 5/16" x 1 1/4" BS46
- S** -  $\phi$  25,32 Splined (SAE 6B)
- SB** -  $\phi$  1 1/4" Splined 14T, DP 12/24
- TA** - Tapered 1:8 SAE. J501, Parallel key 5/16" x 5/16" x 1 1/4"
- TB** - Tapered 1:10, Parallel key B6 x 6 x 20
- SH** -  $\phi$ 31.75[1 1/4]" Splined 14T, DP 12/24
- SL** - 6-34.85 P.T.O. Splined
- C1** -  $\phi$ 25 Straight Parallel Key A8 x 7 x 32
- C2** -  $\phi$ 1" Straight Parallel Key 1/4" x 1/4" x 1 1/4"

**Pos.5 Porting**

Omit - G1/2

- M** - 2 x M22 x 1.5, 15 depth
- U** - 2 x 7/8-14UNF

**Pos.6 Painting**

Omit - Grey

- B** - Black
- 00** - No Paint

**Pos.4 Shaft Extensions**

- CO** -  $\phi$  1 1/4" Straight, Parallel key 5/16" x 5/16" x 1 1/4" BS46
- C** -  $\phi$  32 Straight, Parallel key A10 x 8 x 45
- TB** - Tapered 1:10, Parallel key B6 x 6 x 20
- SB** -  $\phi$  1 1/4" Splined 14T, DP 12/24
- S** -  $\phi$  25,32 Splined (SAE. 6B)
- TA** - Tapered 1:8 SAE. J501, Parallel key 5/16" x 5/16" x 1 1/4"

**Pos.5 Porting**

- U** - 2 x 7/8-14UNF
- M** - 2 x M22 x 1.5, 15 depth
- G** - 2 x G1/2
- MU** - Manifold
- R** - 2 x 1-1/16-12UN

**Pos.6 Painting**

Omit - Grey

- B** - Black
- 00** - No Paint

**Pos.7 Rotation**

Omit - Standard Rotation

- R** - Reverse Rotation